

AIR CONDITIONER

Floor type

DESIGN & TECHNICAL MANUAL

INDOOR



AG*G09LVCB
AG*G12LVCB
AG*G14LVCB

OUTDOOR



AO*G09LVCN
AO*G12LVCN
AO*G14LVCN

FUJITSU GENERAL LIMITED

1.INDOOR UNIT

FLOOR TYPE :

AG*G09LVCB

AG*G12LVCB

AG*G14LVCB

CONTENTS

1. INDOOR UNIT

1. FEATURE	01 - 01
2. WIRELESS REMOTE CONTROLLER	01 - 04
3. SPECIFICATIONS	01 - 06
4. DIMENSIONS	01 - 07
5. WIRING DIAGRAMS	01 - 08
6. CAPACITY TABLE	01 - 09
6-1. COOLING CAPACITY	01 - 09
6-2. HEATING CAPACITY.....	01 - 10
7. FAN PERFORMANCE AND CAPACITY	01 - 11
7-1. AIR VELOCITY DISTRIBUTION.....	01 - 11
7-2. AIR FLOW.....	01 - 12
8. OPERATION NOISE	01 - 14
8-1. NOISE LEVEL CURVE	01 - 14
8-2. SOUND LEVEL CHECK POINT	01 - 16
9. ELECTRIC CHARACTERISTICS	01 - 17
10. SAFETY DEVICES	01 - 18
11-1. EXTERNAL INPUT	01 - 19
11-2. EXTERNAL OUTPUT.....	01 - 21
12. FUNCTION SETTING	01 - 23
12-1. INDOOR UNIT (Setting by remote controller).....	01 - 23
13. OPTIONAL PARTS	01 - 28

1. FEATURE

MODEL

AG*G09LVCB / AO*G09LVCN
 AG*G12LVCB / AO*G12LVCN
 AG*G14LVCB / AO*G14LVCN



FEATURES

- Energy-Efficiency classification A
 Europe Energy-Efficiency classification A achieved

● ALL DC

- a DC fan motor
- b DC compressor



● Low outdoor air temperature correspondence

Corresponds to heating operation at -25°C outdoor air temperature

Heating
-25 to 24°C

Specification improvement that can be operated under extreme low outdoor temperature (-25°C) without trouble

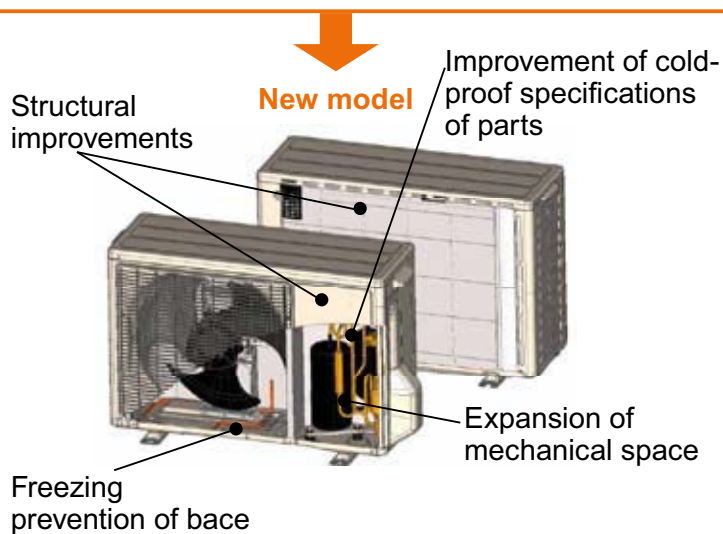

● Powerful heating at low outdoor temperature

Keeping the high heating capacity at low outdoor temperature.

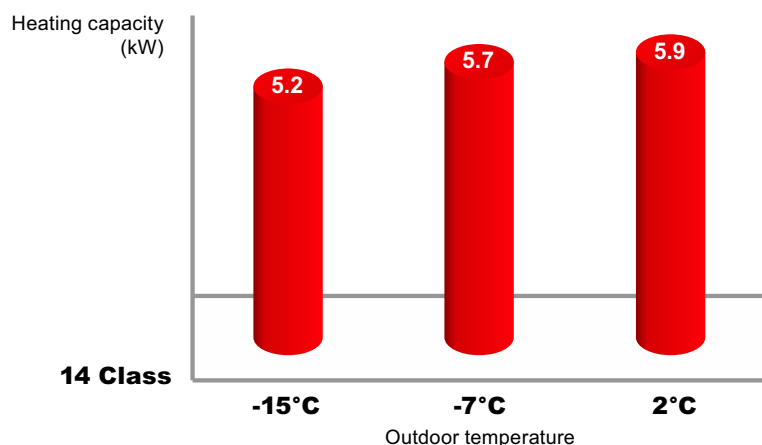
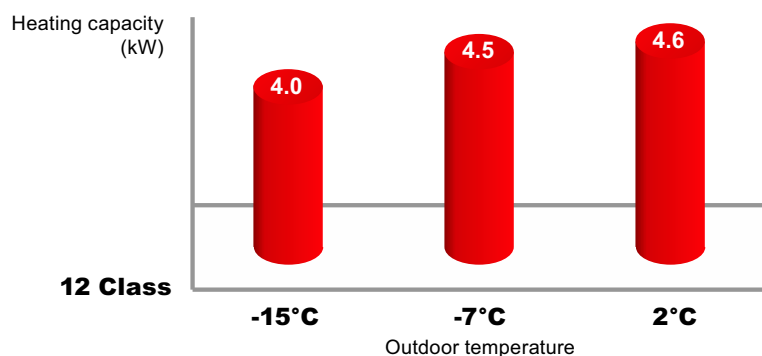
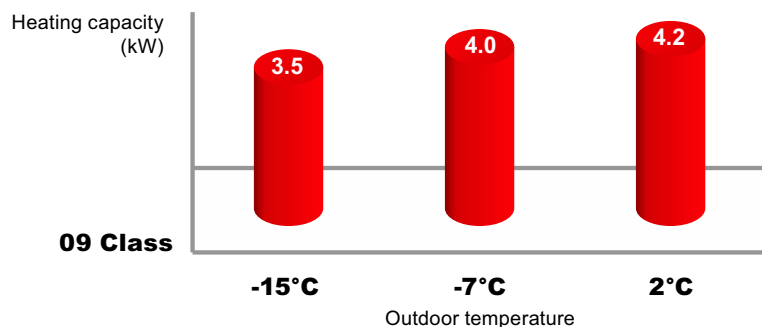

● Powerful operation

*Only available with Wireless RC.

Powerful operation is boosted with the maximum full power and strong airflow. Rapid cooling and heating makes the room comfortable quickly.

Caution

Powerful mode operates for 6 minutes or more, and stops automatically if reaching set temperature or 20 minutes pass.

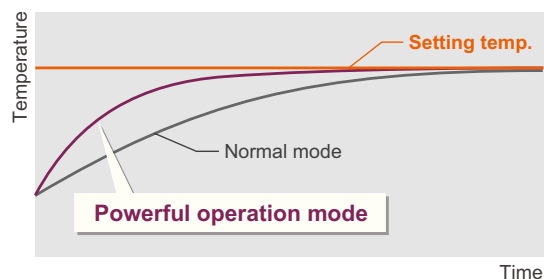

● Up and down twin fan operation

Up to every corner of the room especially around the feet is heated evenly by two-direction up and down discharge.

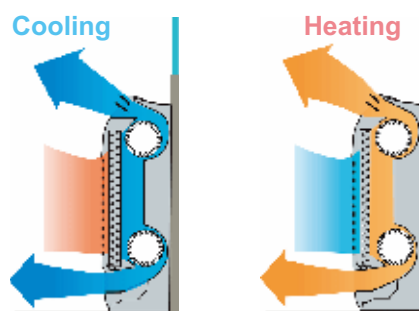

● Flexible & easy installation

Piping space is wide and connection work is easy.

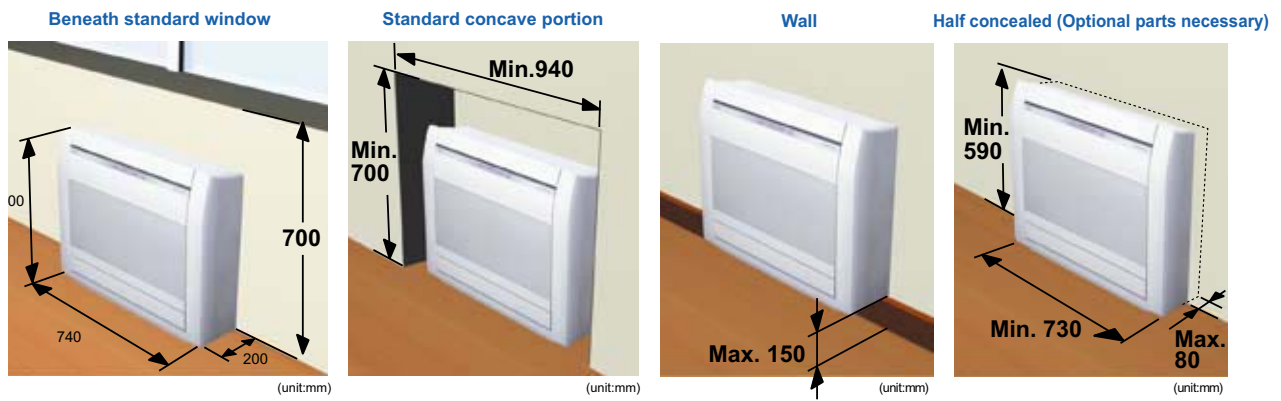

Choice of 6-direction drain & piping connection

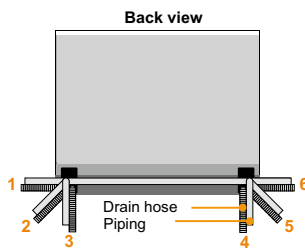

Space is wide and piping work is easy



● Super quiet operation

Air flow mode can be set in 4 steps and more detailed air flow setting is possible.

● 10°C heating operation

Operates in the 10°C heating mode so that the room does not become too cold even when you are absent during the winter, etc.

● Economy operation

Example : Cooling operation

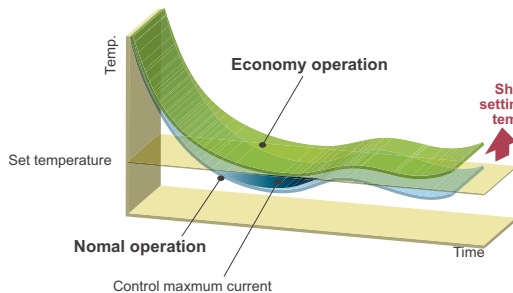

• Economy operation is energy saving, as the set temperature of indoor unit is shifted by 1°C and the maximum electric value of the outdoor unit is suppressed.

● Air conditioner filter feature

Apple-catechin filter



Long-life ion deodorization filter



2. WIRELESS REMOTE CONTROLLER

■ FEATURES



- * Four kinds of timer setup (ON / OFF / PROGRAM / SLEEP) are possible.
- * Four kinds of timers. Easy operation.
- * Easy to change transmission code (4 patterns) by button operation.

● Built-in timers

Select from four different timer programs (ON / OFF / PROGRAM / SLEEP).

● Program timer

The program timer operates the ON and OFF timer once within a 24 hour period.

● Sleep timer

The sleep timer function automatically corrects the temperature thermostat setting according to the timer setting to prevent excessive cooling and heating while sleeping.

Cooling operation/dry operation

When the sleep timer is set, the set temperature automatically rises 1 °C every hour. The set temperature can rise up to a maximum of 2 °C.

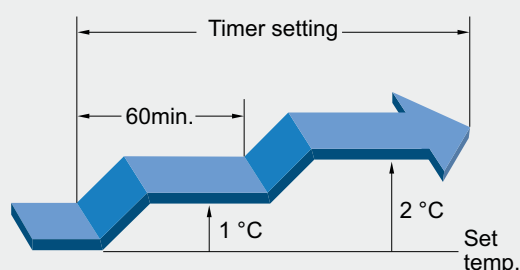

Heating operation

When the sleep timer is set, the set temperature automatically drops 1 °C every 30 minutes. The set temperature can drop to a maximum of 4 °C.

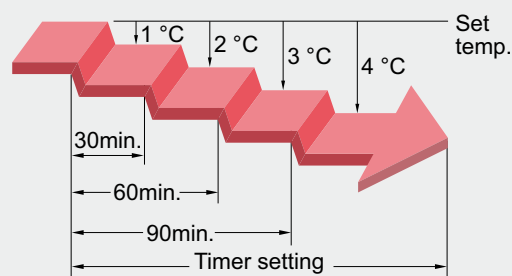

● Simple function setting

Setting of the air conditioner selection function is performed by remote controller.

● Switching remote controller signal code

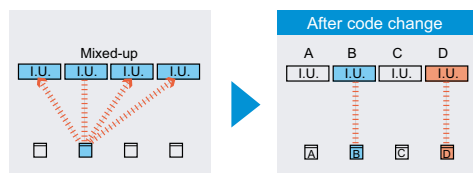

- Code selector switch eliminates unit being wrongly switched.
(Up to 4 codes can be set.)

*I.U.=Indoor unit

FUNCTIONS

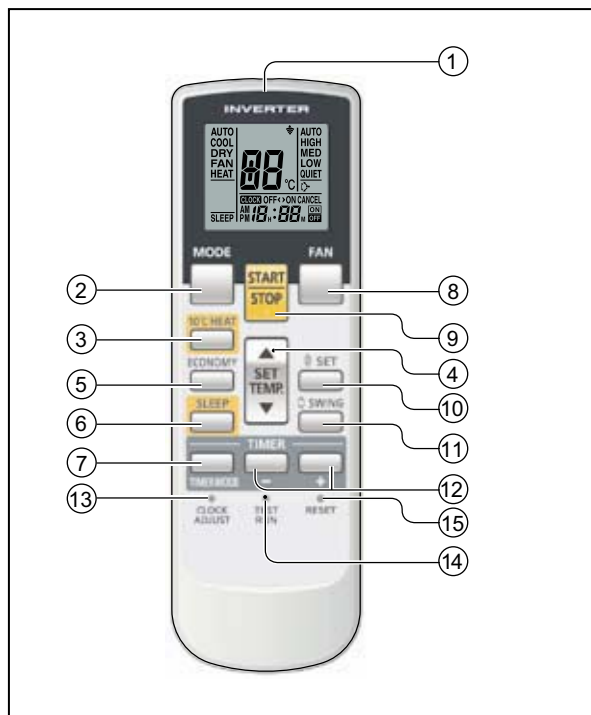

- 1 Signal transmitter
- 2 MODE button
- 3 10°C HEAT button
- 4 SET TEMP. button (▲ / ▼)
- 5 ECONOMY button
- 6 SLEEP button
- 7 TIMER MODE button
- 8 FAN button
- 9 START/STOP button
- 10 SET button
- 11 SWING button
- 12 TIMER SET (+ / -) button
- 13 CLOCK ADJUST button
- 14 TEST RUN button

- This button is used when installing the air conditioner, and should not be used under normal conditions, as it will cause the indoor unit's thermostat function to operate incorrectly.
- If this button is pressed during normal operation, the indoor unit will switch to test operation mode, and the Indoor Unit's OPERATION Indicator Lamp and TIMER Indicator Lamp will begin to flash simultaneously.
- To stop the test operation mode, press the START/STOP button to stop the air conditioner.

Display panel

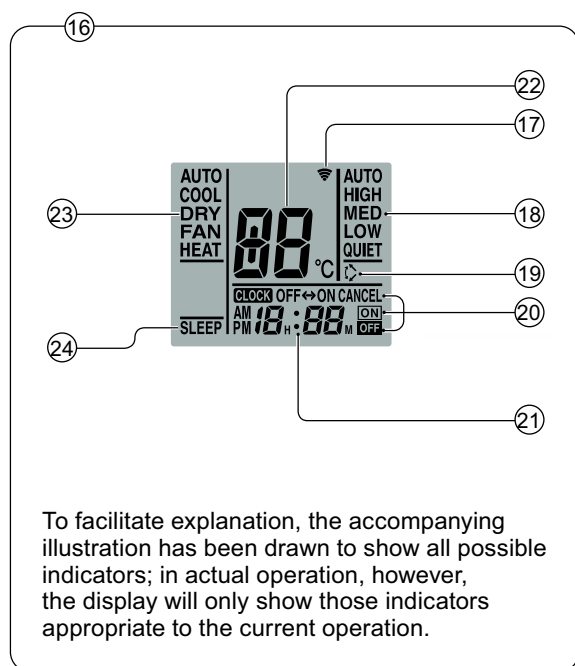

- 15 RESET button
- 16 Remote controller display
- 17 Transmit indicator
- 18 Fan speed display
- 19 Swing display
- 20 Timer mode display
- 21 Clock display
- 22 Temperature set display
- 23 Operation mode display
- 24 Sleep display

To facilitate explanation, the accompanying illustration has been drawn to show all possible indicators; in actual operation, however, the display will only show those indicators appropriate to the current operation.

Functions will be different due to type of indoor unit. For details, please see operation manual.

SPECIFICATION

SIZE	(H x W x D mm)	170 x 56 x 19
WEIGHT	(g)	85 (w/o batteries)
ACCESSORY		Holder

3. SPECIFICATIONS

Type				FLOOR TYPE			
				INVERTER HEAT PUMP			
Model name				AG*G09LVCB	AG*G12LVCB	AG*G14LVCB	
Power source				230V~ 50Hz			
Available voltage range				198-264V ~ 50Hz			
European energy label				Cooling	A	A	A
				Heating	A	A	A
Capacity	Cooling	Rated	kW	2.60	3.50	4.20	
			Btu/h	8,900	11,900	14,300	
		Min-Max	kW	0.9 - 3.8	0.9 - 4.2	0.9 - 5.2	
			Btu/h	3,100 - 13,000	3,100 - 14,300	3,100 - 17,700	
	Heating	Rated	kW	3.50	4.50	5.20	
			Btu/h	11,900	15,400	17,700	
		Min-Max	kW	0.9 - 5.5	0.9 - 5.7	0.9 - 6.1	
			Btu/h	3,100 - 18,800	3,100 - 19,500	3,100 - 20,800	
Input power	Cooling	Rated	kW	0.530	0.910	1.140	
				Min-Max	0.20 - 2.05		0.18 - 2.16
	Heating	Rated		0.790	1.190	1.440	
				Min-Max	0.20 - 2.62		0.18 - 3.30
Current	Cooling	Rated	A	2.7	4.4	5.2	
				Max	9.0		9.5
	Heating	Rated		3.9	5.6	6.5	
				Max	11.5		14.5
EER			Cooling	4.91	3.85	3.68	
COP			Heating	4.43	3.78	3.61	
SENSIBLE CAPACITY			Cooling	kW	1.71	2.28	2.78
POWER FACTOR			Cooling	%	85	90	95
			Heating		88	92	96
Moisture removal				l/h (pints/h)	1.3 (2.3)	1.8 (3.2)	2.1 (3.7)
Fan	Airflow rate	Cooling	m ³ /h	High	570	650	
				Med	460	520	
				Low	360	400	
				Quiet	270	270	
		Heating		High	600	650	
				Med	480	520	
				Low	370	390	
				Quiet	270	270	
	Type × Q'ty			Cross flow fan × 2			
	Motor output			W	42		
Sound pressure level	Cooling	dB(A)	High	40	40	44	
			Med	35	35	38	
			Low	29	29	31	
			Quiet	22	22	22	
	Heating		High	40	40	43	
			Med	35	35	37	
			Low	29	29	29	
			Quiet	22	22	22	
Heat exchanger type	Dimensions (H × W × D)		mm	378 × 550 × 26.6			
	Fin pitch			1.2			
	Rows x Stages			2 × 18			
	Pipe type			Copper			
	Fin type			Aluminium			
Enclosure	Material		Polystyrene				
	Colour		White (Approximate colour of MUNSELL N9.25 /)				
Dimensions (H×W ×D)	Net		mm	600 × 740 × 200			
	Gross			700 × 820 × 310			
Weight	Net		kg	14			
	Gross			17			
Connection pipe	Size	Liquid	mm	Φ6.35 (Φ 1/4 in.)			
		Gas		Φ9.52 (Φ 3/8 in.)		Φ12.70 (Φ 1/2 in.)	
	Method			Flare			
Operation range	Cooling	°C	18 to 32				
		%RH	80 or less				
	Heating	°C	16 to 30				
Remote controller type				Wireless			
Drain pipe	Material		PP + LLDPE				
	Size		mm	Outer diameter: 29 / Inner diameter: 13.6			

Note :
 Specifications are based on the following conditions.
 Cooling : Indoor temperature of 27 °CDB / 19 °CWB and outdoor temperature of 35 °CDB/24 °CWB.
 Heating : Indoor temperature of 20 °CDB / 15 °CWB and outdoor temperature of 7 °CDB/6 °CWB.
 Pipe length : 5 m, Height difference : 0 m.(Outdoor unit - Indoor unit)
 The maximum current is the maximum value when the operated within the operation range (temperature).
 The protective function might work when using it outside the operation range.

4. DIMENSIONS

■ MODEL: AG*G09LV, AG*G12LV, AG*G14LV

(Unit : mm)

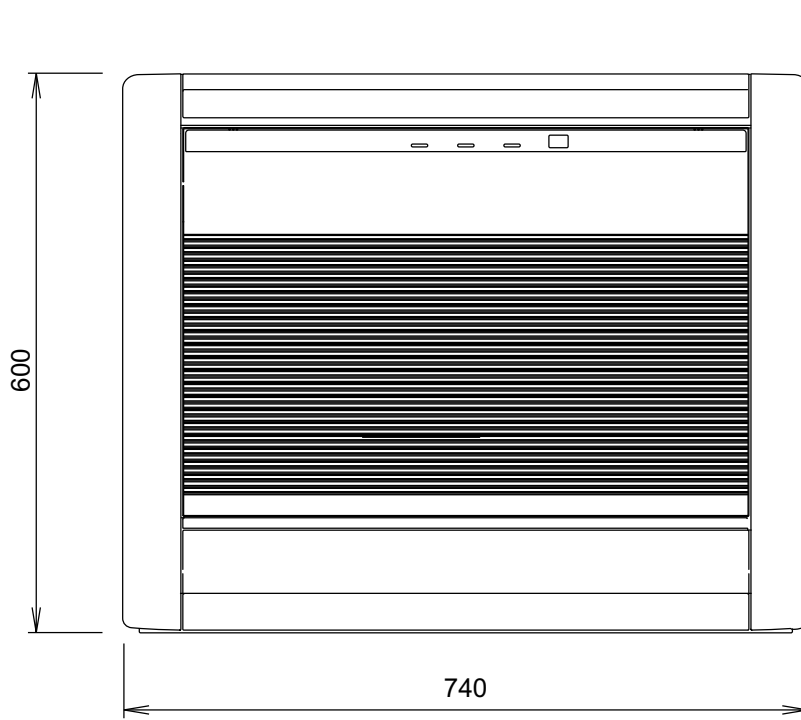

Front view

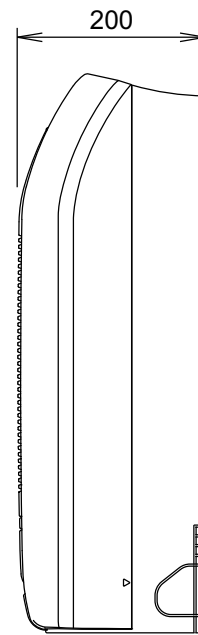

Side view

■ INSTALLATION PLACE

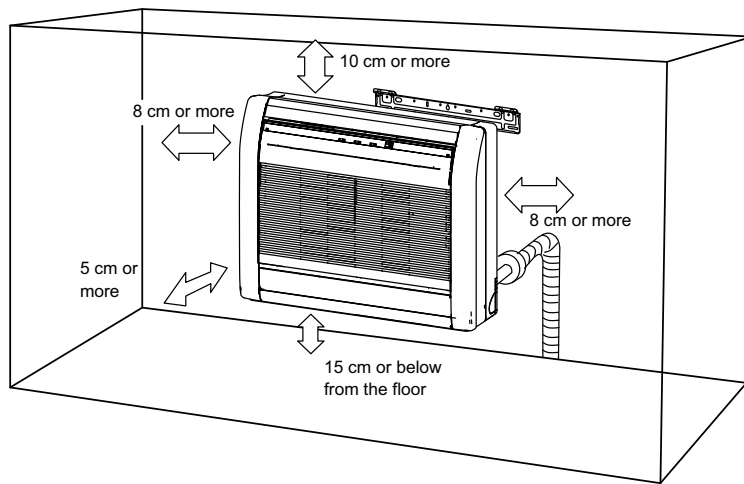

5. WIRING DIAGRAMS

■ MODEL: AG*G09LV, AG*G12LV, AG*G14LV

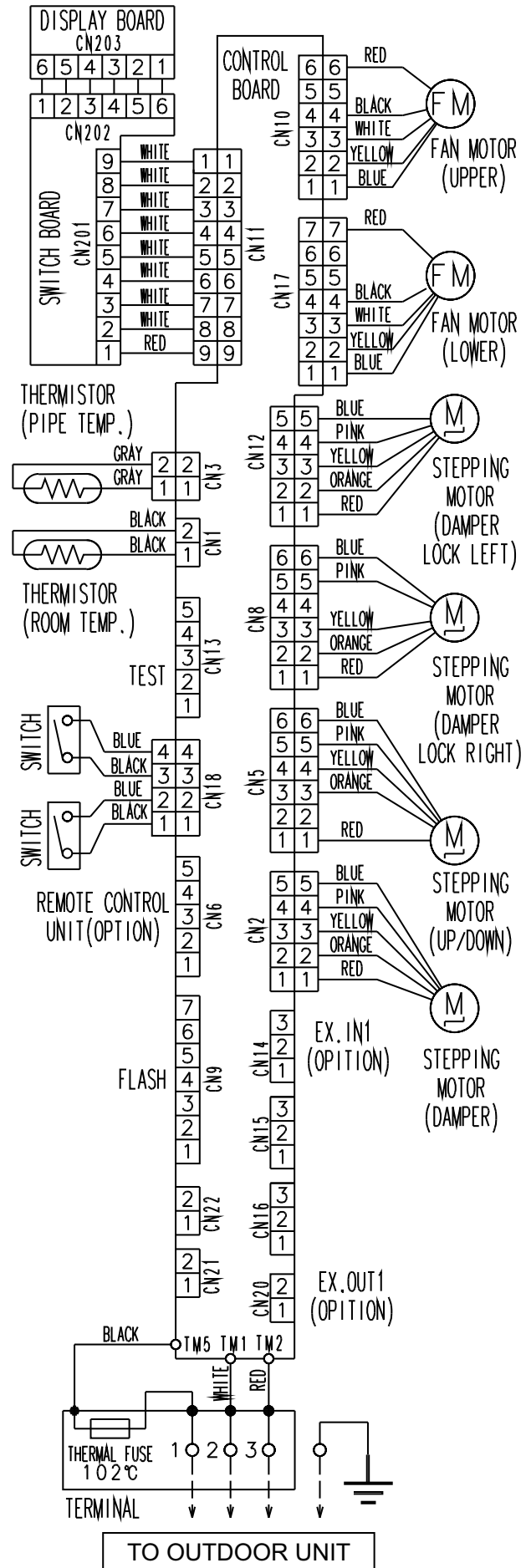

6. CAPACITY TABLE

6-1. COOLING CAPACITY

MODEL: AG*G09LV

AFR	9.5
-----	-----

		Indoor temperature																						
		18			21			23			25			27			29			32				
		12			15			16			18			19			21			23				
Outdoor temperature	°CDB	TC	SHC	IP	TC	SHC	IP	TC	SHC	IP	TC	SHC	IP	TC	SHC	IP	TC	SHC	IP	TC	SHC	IP		
	20	2.43	1.72	0.37	2.71	1.73	0.38	2.80	1.88	0.38	2.99	1.89	0.38	3.08	2.04	0.39	3.27	2.03	0.39	3.45	2.16	0.39		
	25	2.31	1.63	0.42	2.57	1.64	0.42	2.66	1.79	0.43	2.84	1.79	0.43	2.93	1.94	0.43	3.10	1.93	0.44	3.28	2.05	0.44		
	30	2.18	1.54	0.46	2.43	1.55	0.47	2.52	1.69	0.47	2.68	1.69	0.48	2.77	1.83	0.48	2.93	1.82	0.49	3.10	1.94	0.49		
	35	2.05	1.45	0.51	2.29	1.46	0.52	2.37	1.59	0.52	2.52	1.59	0.53	2.60	1.72	0.53	2.76	1.71	0.54	2.91	1.82	0.54		
	40	1.83	1.29	0.51	2.04	1.30	0.52	2.11	1.41	0.52	2.25	1.42	0.53	2.32	1.53	0.53	2.46	1.53	0.53	2.59	1.63	0.54		
	43	1.70	1.20	0.51	1.89	1.21	0.52	1.96	1.31	0.52	2.08	1.32	0.53	2.15	1.42	0.53	2.28	1.42	0.53	2.41	1.51	0.54		

MODEL: AG*G12LV

AFR	9.5
-----	-----

		Indoor temperature																						
		18			21			23			25			27			29			32				
		12			15			16			18			19			21			23				
Outdoor temperature	°CDB	TC	SHC	IP	TC	SHC	IP	TC	SHC	IP	TC	SHC	IP	TC	SHC	IP	TC	SHC	IP	TC	SHC	IP		
	20	3.28	2.28	0.62	3.65	2.30	0.63	3.77	2.50	0.64	4.02	2.50	0.64	4.15	2.70	0.65	4.40	2.69	0.65	4.64	2.87	0.66		
	25	3.12	2.17	0.71	3.47	2.18	0.72	3.59	2.37	0.72	3.83	2.38	0.73	3.95	2.57	0.73	4.18	2.56	0.74	4.42	2.72	0.75		
	30	2.95	2.05	0.79	3.28	2.06	0.80	3.40	2.24	0.81	3.62	2.25	0.82	3.73	2.43	0.82	3.96	2.42	0.83	4.18	2.57	0.84		
	35	2.77	1.93	0.88	3.08	1.94	0.89	3.19	2.11	0.90	3.40	2.11	0.91	3.50	2.28	0.91	3.71	2.27	0.92	3.92	2.42	0.93		
	40	2.34	1.72	0.82	2.60	1.73	0.83	2.69	1.88	0.83	2.87	1.88	0.84	2.96	2.03	0.85	3.14	2.02	0.85	3.31	2.16	0.86		
	43	2.15	1.59	0.82	2.40	1.60	0.83	2.48	1.74	0.83	2.64	1.75	0.84	2.72	1.89	0.85	2.89	1.88	0.86	3.05	2.00	0.86		

MODEL: AG*G14LV

AFR	10.8
-----	------

		Indoor temperature																						
		18			21			23			25			27			29			32				
		12			15			16			18			19			21			23				
Outdoor temperature	°CDB	TC	SHC	IP	TC	SHC	IP	TC	SHC	IP	TC	SHC	IP	TC	SHC	IP	TC	SHC	IP	TC	SHC	IP		
	20	3.91	2.76	0.79	4.35	2.78	0.81	4.50	3.02	0.81	4.80	3.03	0.82	4.95	3.27	0.82	5.24	3.26	0.83	5.54	3.47	0.84		
	25	3.72	2.63	0.90	4.15	2.65	0.91	4.29	2.88	0.91	4.57	2.89	0.92	4.71	3.12	0.93	5.00	3.11	0.94	5.28	3.31	0.95		
	30	3.53	2.50	1.00	3.93	2.51	1.01	4.07	2.73	1.02	4.34	2.74	1.03	4.47	2.96	1.03	4.74	2.95	1.04	5.01	3.14	1.05		
	35	3.32	2.35	1.10	3.70	2.36	1.12	3.82	2.56	1.12	4.07	2.57	1.13	4.20	2.78	1.14	4.45	2.77	1.15	4.70	2.95	1.16		
	40	2.92	2.06	1.08	3.25	2.07	1.10	3.36	2.25	1.11	3.58	2.26	1.12	3.69	2.44	1.12	3.91	2.43	1.13	4.13	2.59	1.15		
	43	2.66	1.88	1.07	2.96	1.89	1.08	3.06	2.05	1.09	3.26	2.06	1.10	3.36	2.22	1.11	3.56	2.22	1.12	3.77	2.36	1.13		

AFR: Air Flow Rate (m³/min.)
 TC: Total Capacity (kW)
 SHC: Sensible Heat Capacity (kW)
 IP: Input Power (kW)

6-2. HEATING CAPACITY

This table is created using the maximum capacity.

MODEL: AG*G09LV

AFR	10.0
-----	------

		Indoor temperature										
		°CDB		16		18		20		22		24
Outdoor temperature	°CDB	°CWB	TC	IP	TC	IP	TC	IP	TC	IP	TC	IP
	-25	-26	2.63	1.82	2.56	1.86	2.50	1.90	2.44	1.94	2.38	1.98
	-20	-21	3.15	1.92	3.08	1.96	3.00	2.00	2.93	2.04	2.85	2.08
	-15	-16	3.68	2.02	3.59	2.06	3.50	2.10	3.41	2.14	3.33	2.18
	-10	-11	4.00	2.05	3.91	2.09	3.81	2.13	3.72	2.17	3.62	2.22
	-5	-7	4.25	1.97	4.15	2.02	4.04	2.06	3.94	2.10	3.84	2.14
	0	-2	4.36	1.75	4.26	1.79	4.16	1.82	4.05	1.86	3.95	1.90
	5	3	5.23	1.69	5.10	1.72	4.98	1.76	4.86	1.80	4.73	1.83
	7	6	5.78	1.71	5.64	1.74	5.50	1.78	5.36	1.82	5.23	1.85
	10	8	6.38	1.72	6.23	1.75	6.08	1.79	5.93	1.83	5.77	1.86
15	10	6.61	1.73	6.46	1.76	6.30	1.80	6.14	1.84	5.98	1.87	

MODEL: AG*G12LV

AFR	10.0
-----	------

		Indoor temperature										
		°CDB		16		18		20		22		24
Outdoor temperature	°CDB	°CWB	TC	IP	TC	IP	TC	IP	TC	IP	TC	IP
	-25	-26	3.15	1.82	3.08	1.86	3.00	1.90	2.93	1.94	2.85	1.98
	-20	-21	3.68	1.92	3.59	1.96	3.50	2.00	3.41	2.04	3.33	2.08
	-15	-16	4.20	2.02	4.10	2.06	4.00	2.10	3.90	2.14	3.80	2.18
	-10	-11	4.53	2.05	4.42	2.09	4.31	2.13	4.20	2.17	4.10	2.22
	-5	-7	4.75	1.97	4.64	2.02	4.52	2.06	4.41	2.10	4.30	2.14
	0	-2	4.81	1.75	4.69	1.79	4.58	1.82	4.46	1.86	4.35	1.90
	5	3	5.52	1.69	5.39	1.72	5.26	1.76	5.13	1.80	5.00	1.83
	7	6	5.99	1.71	5.84	1.74	5.70	1.78	5.56	1.82	5.42	1.85
	10	8	6.61	1.72	6.46	1.75	6.30	1.79	6.14	1.83	5.98	1.86
15	10	6.85	1.73	6.69	1.76	6.53	1.80	6.36	1.84	6.20	1.87	

MODEL: AG*G14LV

AFR	10.8
-----	------

		Indoor temperature										
		°CDB		16		18		20		22		24
Outdoor temperature	°CDB	°CWB	TC	IP	TC	IP	TC	IP	TC	IP	TC	IP
	-25	-26	4.41	2.64	4.31	2.70	4.20	2.75	4.10	2.81	3.99	2.86
	-20	-21	4.94	2.74	4.82	2.79	4.70	2.85	4.58	2.91	4.47	2.96
	-15	-16	5.46	2.83	5.33	2.89	5.20	2.95	5.07	3.01	4.94	3.07
	-10	-11	5.79	2.75	5.65	2.81	5.51	2.87	5.37	2.93	5.24	2.98
	-5	-7	6.03	2.55	5.89	2.61	5.74	2.66	5.60	2.71	5.46	2.77
	0	-2	6.15	2.17	6.00	2.21	5.86	2.26	5.71	2.31	5.56	2.35
	5	3	6.32	1.93	6.17	1.97	6.02	2.01	5.87	2.05	5.72	2.09
	7	6	6.41	1.87	6.25	1.91	6.10	1.95	5.95	1.99	5.80	2.03
	10	8	7.08	1.94	6.91	1.98	6.74	2.02	6.57	2.06	6.40	2.10
15	10	7.34	1.95	7.16	1.99	6.99	2.03	6.81	2.07	6.64	2.11	

AFR: Air Flow Rate (m³/min.)
TC: Total Capacity (kW)
IP: Input Power (kW)

7. FAN PERFORMANCE AND CAPACITY

7-1. AIR VELOCITY DISTRIBUTION

■ MODEL: AG*G09LV, AG*G12LV, AG*G14LV

(m) Unit : m/s

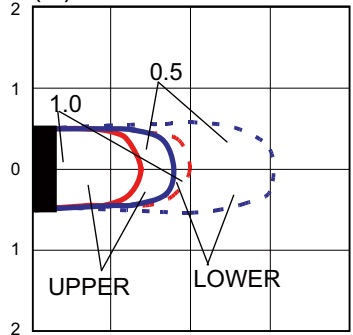

TOP VIEW
FLOW CONTROL PANEL : Horiz.
LOUVER : Center

Note:

- Fan speed : H i
- Operation mode:FAN
- Fan select : UPPER&LOWER
- :UPPER FAN
- - - - - :LOWER FAN

(m)

(m) Unit : m/s

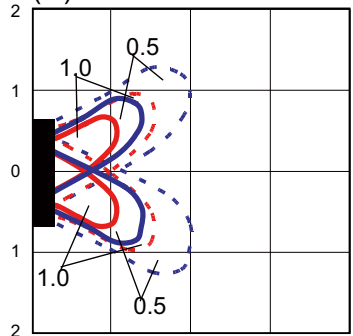

TOP VIEW
FLOW CONTROL PANEL : Horiz.
LOUVER : Right & Left

(m)

(m) Unit : m/s

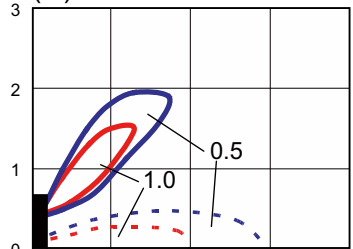

SIDE VIEW
FLOW CONTROL PANEL : Vert
LOUVER : Center

(m)

(m) Unit : m/s

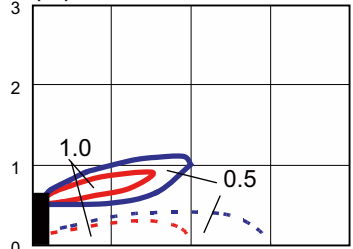

SIDE VIEW
FLOW CONTROL PANEL : Horiz.
LOUVER : Center

(m)

7-2. AIR FLOW

■ MODEL: AG*G09LV, AG*G12LV

● Cooling

Fan speed	Number of rotations (r.p.m)	Air flow	
HIGH	1190/1000	570	m ³ /h
		158	l/s
		335	CFM
MED	1000/850	460	m ³ /h
		128	l/s
		271	CFM
LOW	820/690	360	m ³ /h
		100	l/s
		212	CFM
QUIET	660/560	270	m ³ /h
		75	l/s
		159	CFM

● Heating

Fan speed	Number of rotations (r.p.m)	Air flow	
HIGH	1240/1040	600	m ³ /h
		167	l/s
		353	CFM
MED	1040/880	480	m ³ /h
		133	l/s
		282	CFM
LOW	840/700	370	m ³ /h
		103	l/s
		218	CFM
QUIET	660/560	270	m ³ /h
		75	l/s
		159	CFM

■ MODEL: AG*G14LV

● Cooling

Fan speed	Number of rotations (r.p.m)	Air flow	
HIGH	1330/1120	650	m ³ /h
		181	l/s
		383	CFM
MED	1100/930	520	m ³ /h
		144	l/s
		306	CFM
LOW	890/750	400	m ³ /h
		111	l/s
		235	CFM
QUIET	660/560	270	m ³ /h
		75	l/s
		159	CFM

● Heating

Fan speed	Number of rotations (r.p.m)	Air flow	
HIGH	1330/1120	650	m ³ /h
		181	l/s
		383	CFM
MED	1100/930	520	m ³ /h
		144	l/s
		306	CFM
LOW	860/730	390	m ³ /h
		108	l/s
		230	CFM
QUIET	660/560	270	m ³ /h
		75	l/s
		159	CFM

8. OPERATION NOISE

8-1. NOISE LEVEL CURVE

MODEL: AG*G09LV

● Cooling

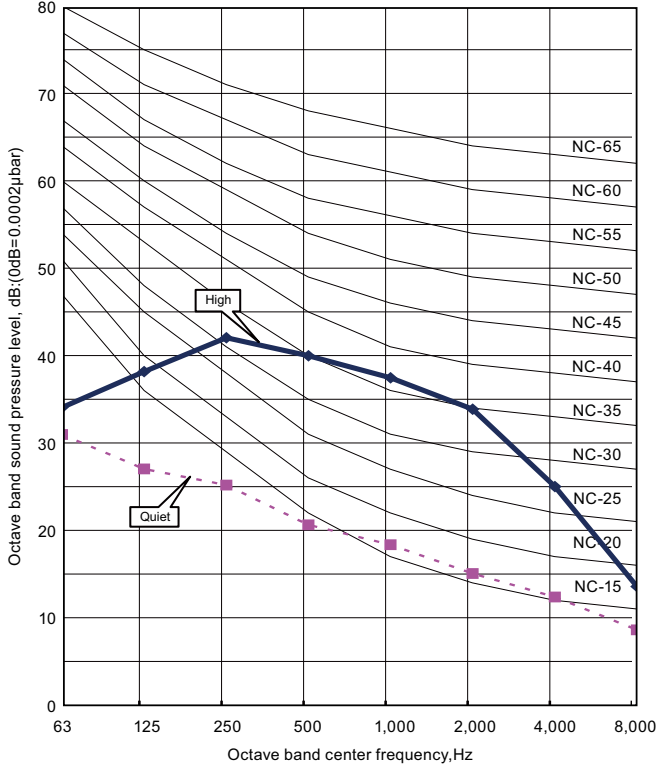

● Heating

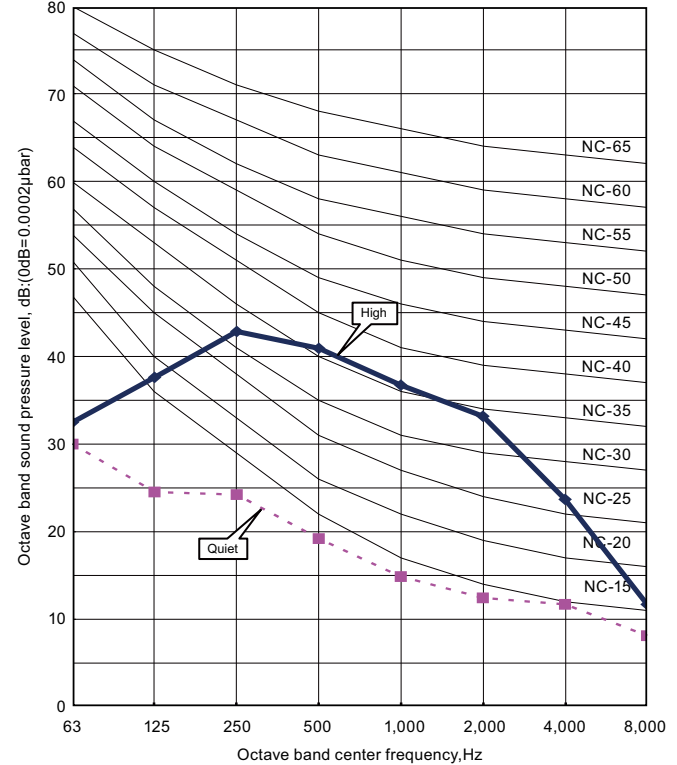

MODEL: AG*G12LV

● Cooling

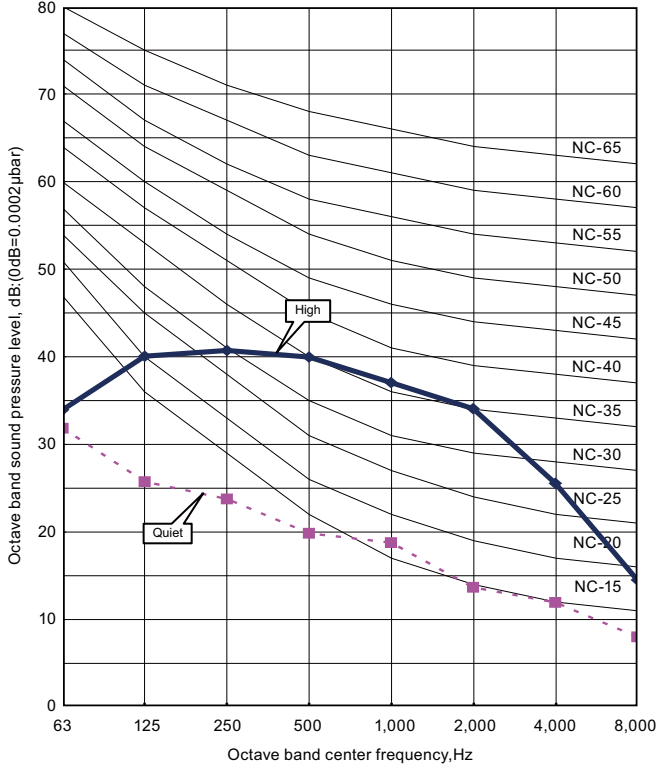

● Heating

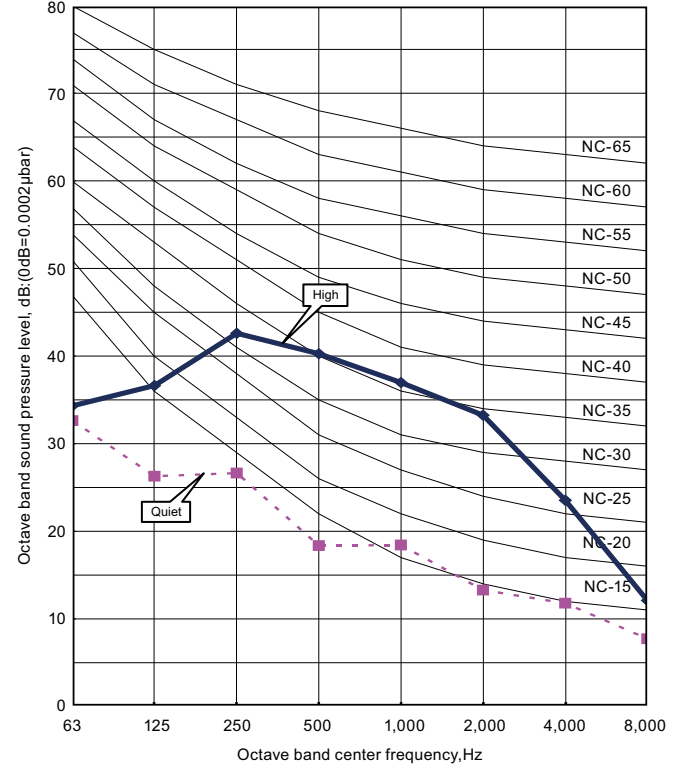

MODEL: AG*G14LV

● Cooling

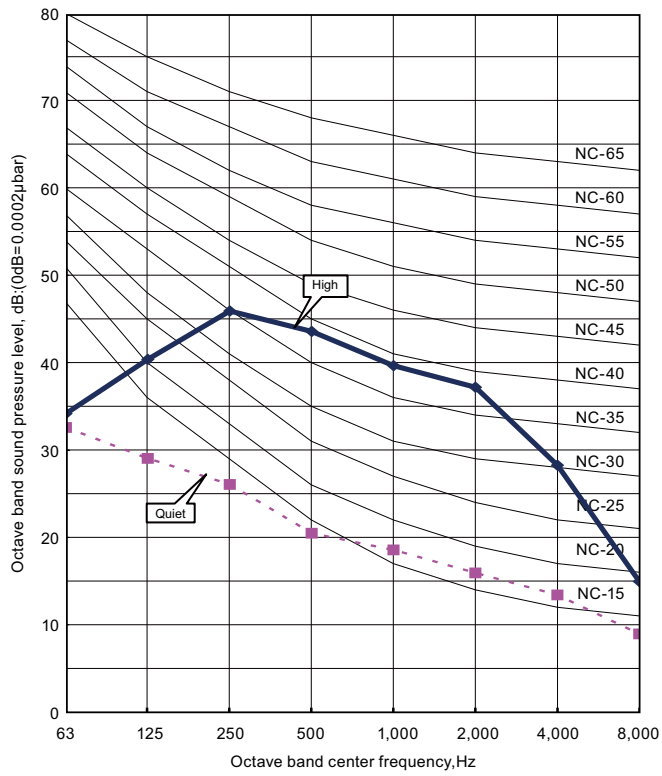

● Heating

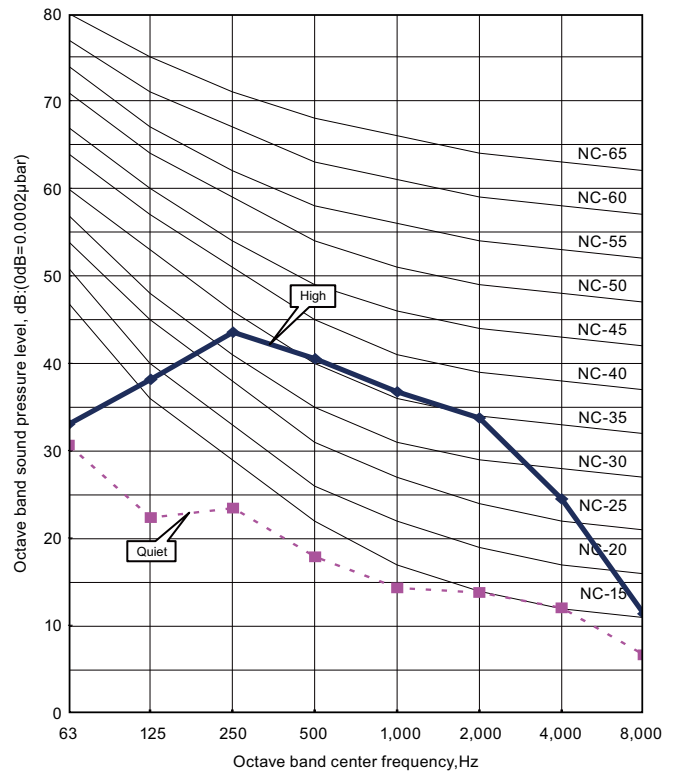

8-2. SOUND LEVEL CHECK POINT

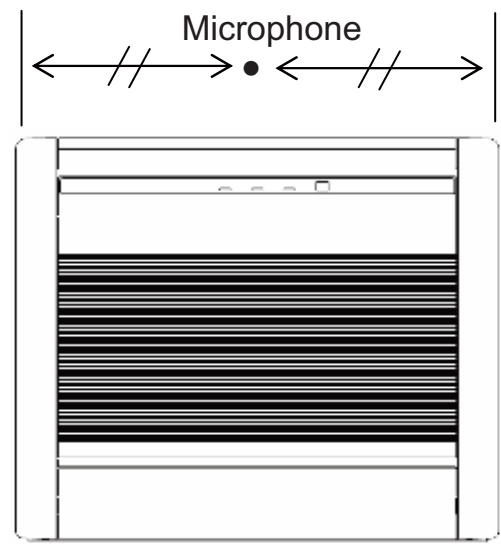
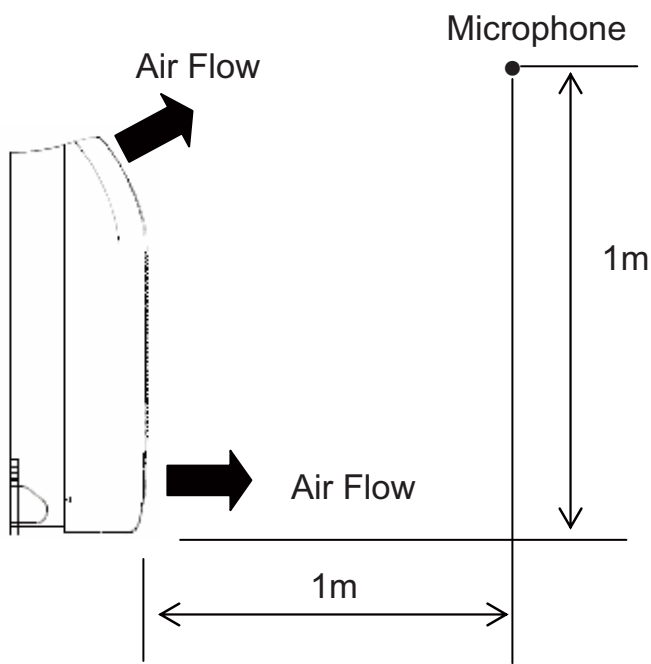

9. ELECTRIC CHARACTERISTICS

Model Name			AG*G09LV	AG*G12LV	AG*G14LV
Power Supply	Voltage	V	230 ~		
	Frequency	Hz	50		
Max Operating Current		A	0.7		
*)Wiring Spec	Connection Cable	mm ²	1.5		
	Limited wiring length	m	21		

*) Wiring Spec
Selected Sample
(Selected based on Japan Electrotechnical Standard and Codes Committee E0005)

10. SAFETY DEVICES

	Protection form	Model		
		AG*G09LV	AG*G12LV	AG*G14LV
Circuit protection	Current fuse (PCB)	3.15A 250V		
Terminal protection	Current (thermal) fuse	3A 250V		
Fan motor protection	Terminal protection program	100 ⁺¹⁵ ₋₁₀ °C OFF 95 ⁺⁵ ₋₁₀ °C ON		

11. EXTERNAL INPUT & OUTPUT

Connector	INPUT	OUTPUT	REMARKS
CN14	Control input	-	See external input/output settings for details.
CN20	-	Operation status output	
CN21	-	Error status output	

11-1. EXTERNAL INPUT

■ CONTROL INPUT (Operation/Stop or Forced stop)

The air conditioner can be remotely operated by means of the following on-site work.

"Operation/Stop" mode or "Forced stop" mode can be selected with function setting of indoor unit.

Unit operation is started at the following contents by adding the contact input of a commercial ON/OFF switch to a connector on the external control PC board and turning it ON.

Unit operation	Initial starting after turned power on	Other than initial starting
Operation mode	Auto changeover	Mode at previous operation
Set temperature	24°C	Temperature at previous operation
Air flow mode	AUTO	Mode at previous operation
Up-down air direction (swing)	Standard air direction (swing OFF)	Air direction at previous operation
Left-right air direction (swing)	Standard air direction (swing OFF)	Air direction at previous operation

● Circuit diagram example

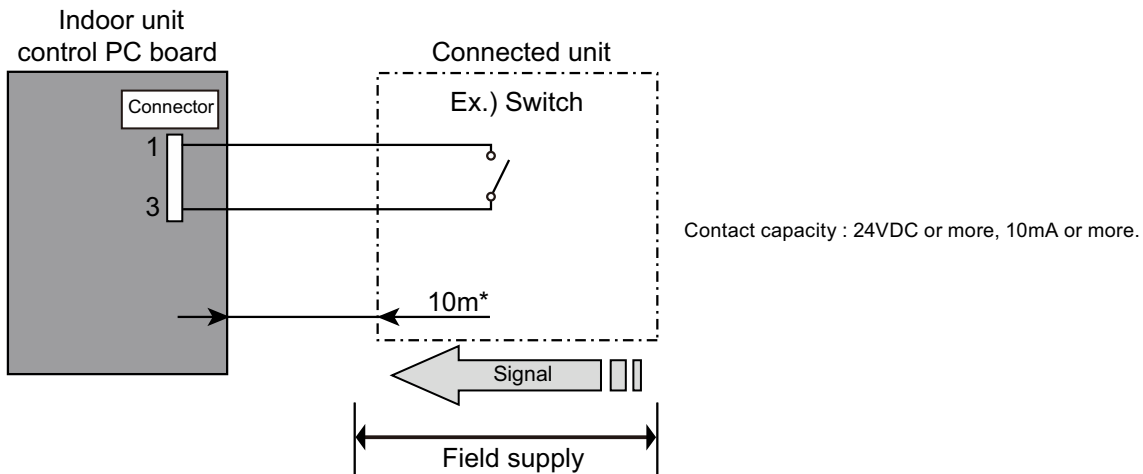

* Make the distance from the PC board to the connected unit within 10m.

● When function setting is "Operation/Stop" mode

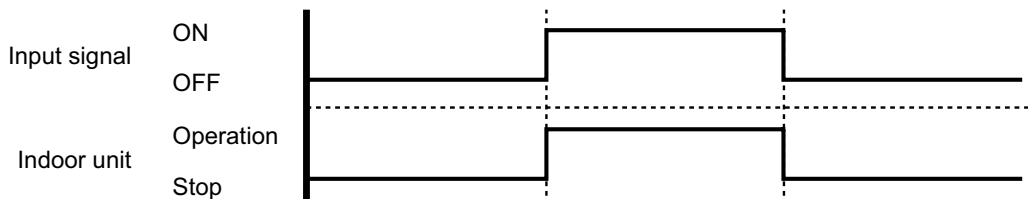

● When function setting is "Forced stop" mode

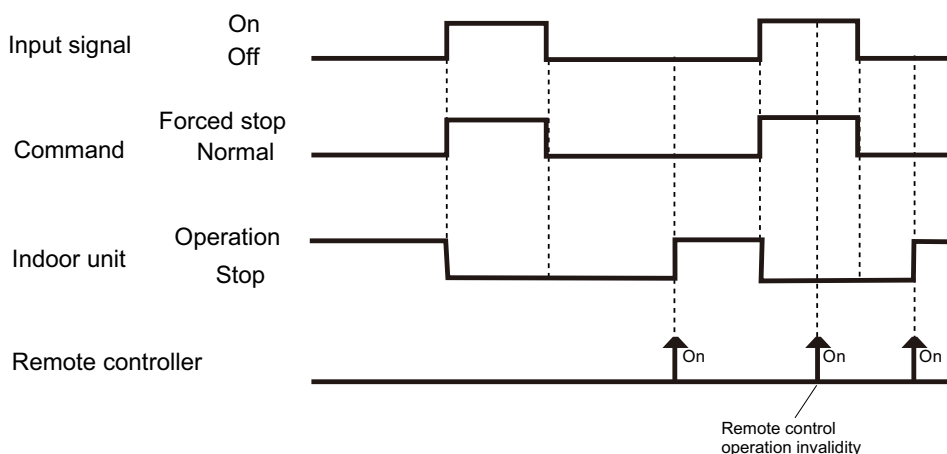

● **Parts (Optional)**

Parts name	Model name
External connect kit	UTY-XWZXZ5

Wire (External input) : UTY-XWZXZ5

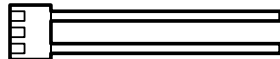

11-2. EXTERNAL OUTPUT

■ OPERATION STATUS OUTPUT

An air conditioner operation status signal can be output.

● Circuit diagram example

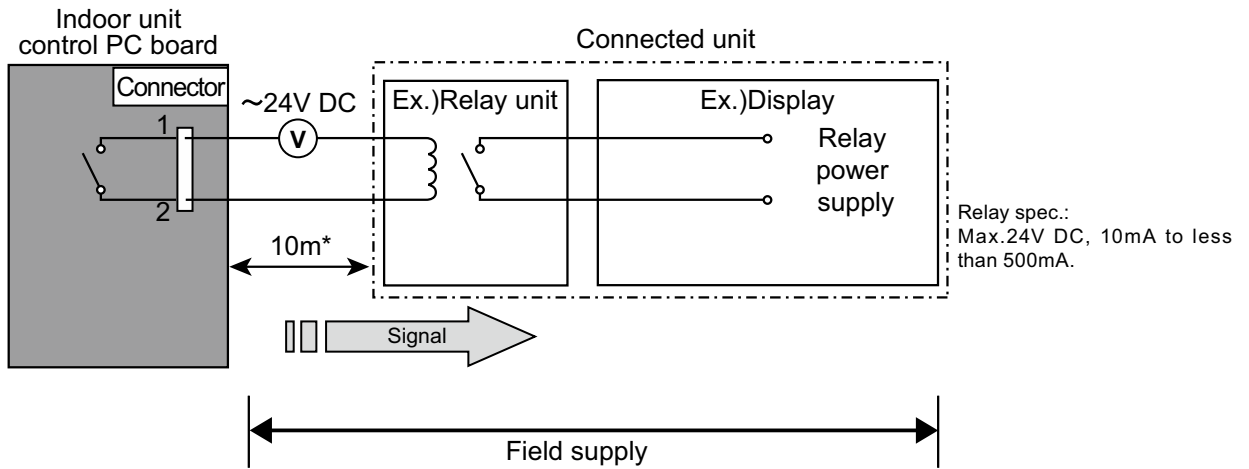

* Make the distance from the PC board to the connected unit within 10m.

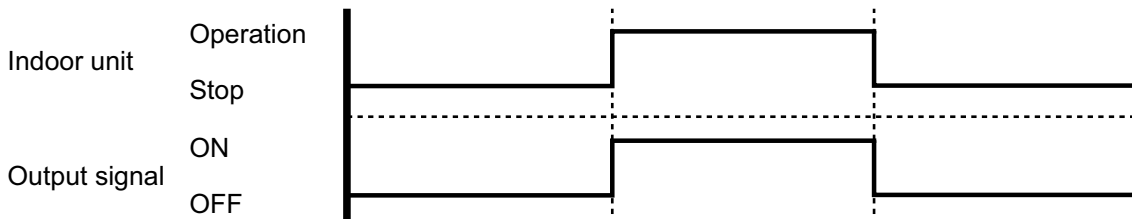

● Parts (Optional)

Parts name	Model name
External connect kit	UTY-XWZXZ5

Wire (External output) : UTY-XWZXZ5

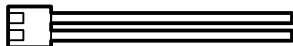

■ ERROR STATUS OUTPUT

An air conditioner error status signal can be output.

● Circuit diagram example

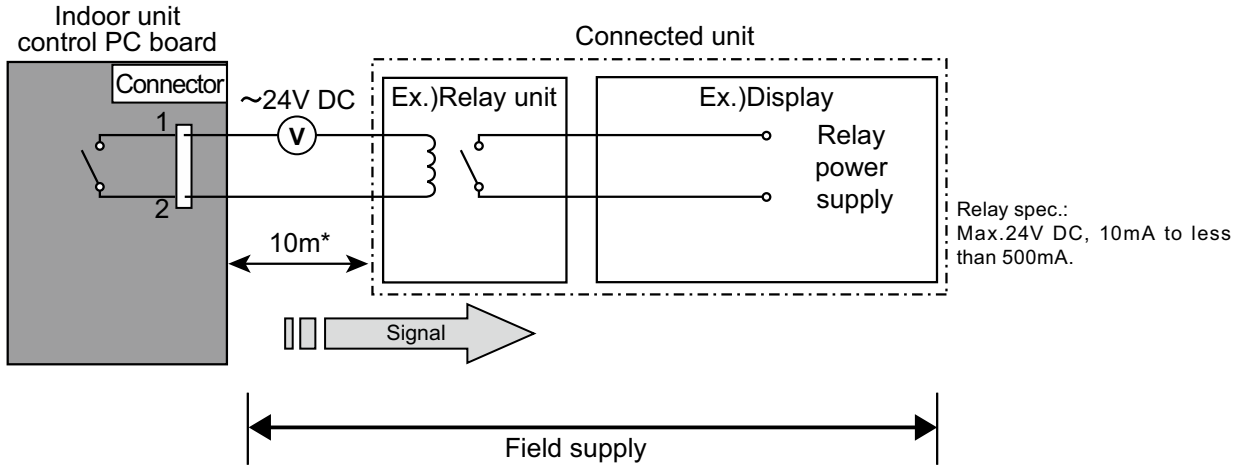

* Make the distance from the PC board to the connected unit within 10m.

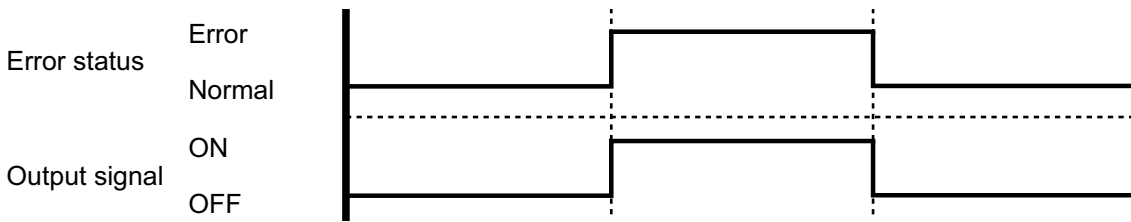

● Parts (Optional)

Parts name	Model name
External connect kit	UTY-XWZXZ5

Wire (External output) : UTY-XWZXZ5



12. FUNCTION SETTING

12-1. INDOOR UNIT (Setting by remote controller)

- This procedure changes to the function settings used to control the indoor unit according to the installation conditions. Incor settings can cause the indoor unit malfunction.
- After the power is turned on, perform the "FUNCTION SETTING" according to the installation conditions using the remote controller.
- The settings may be selected between the following two: Function Number or Setting Value.
- Settings will not be changed if invalid numbers or setting values are selected.

■ PREPARATION

- Turn on the power.
- * By turning on the power indoor units, so make sure the piping air-tight test and vacuuming have been conducted before turning on the power.
- * Also check again to make sure no wiring mistakes were made before turning on the power.

■ FUNCTION SETTING METHOD (for Wireless remote controller)

Entering the Function Setting Mode

- While pressing the FAN button and SET TEMP. (▲) simultaneously, press the RESET button to enter the function setting mode.

STEP 1

Setting the Remote controller Signal Code

Use the following steps to select the signal code of the remote controller. (Note that the air conditioner cannot receive a signal code if the air conditioner has not been set for the signal code.) The signal codes that are set through this process are applicable only to the signals in the FUNCTION SETTING. For details on how to set the signal codes through the normal process, refer to SELECTING THE REMOTE CONTROLLER SIGNAL CODE.

1. Press the SET TEMP. (▲) (▼) button to change the signal code between $A \rightarrow B \rightarrow C \rightarrow D$. Match the code on the display to the air conditioner signal code. (initially set to A)
(If the signal code does not need to be selected, press the MODE button and proceed to STEP 2.)
2. Press the TIMER MODE button and check that the indoor unit can receive signals at the displayed signal code.
3. Press the MODE button to accept the signal code, and proceed to STEP 2.

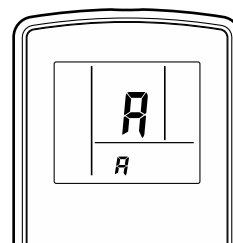

The air conditioner signal code is set to A prior to shipment.

The remote controller resets to signal code A when the batteries in the remote controller are replaced. If you use a signal code other than signal code A, reset the signal code after replacing the batteries. If you do not know the air conditioner signal code setting, try each of the signal codes ($A \rightarrow B \rightarrow C \rightarrow D$) until you find the code which operates the air conditioner.

STEP 2

Selecting the Function Number and Setting Value

1. Press the SET TEMP. (▲) (▼) buttons to select the function number.
(Press the MODE button to switch between the left and right digits.)
2. Press the FAN button to proceed to setting the value.
Press the FAN button again to return to the function number selection.)
3. Press the SET TEMP. (▲) (▼) buttons to select the setting value.
(Press the MODE button to switch between the left and right digits.)
4. Press the TIMER MODE button, and START/STOP button, in the order listed to confirm the settings.
5. Press the RESET button to cancel the function setting mode.
6. After completing the FUNCTION SETTING, be sure to turn off the power and turn it on again.

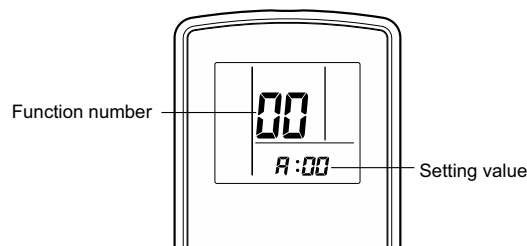

⚠ CAUTION

After turning off the power, wait 10 seconds or more before turning it on again. The FUNCTION SETTING doesn't become effective if it doesn't do so.

FUNCTION DETAILS

	Functions	Floor
1)	Filter sign	●
2)	Embedding the indoor unit in a wall	●
3)	Cooler room temperature correction	●
4)	Heater room temperature correction	●
5)	Auto restart	●
6)	Indoor room temperature sensor switching function	●
7)	Remote controller signal code	●
8)	External input control	●

1) Filter sign

The indoor unit has a sign to inform the user that it is time to clean the filter. Select the time setting for the filter sign display interval in the table below according to the amount of dust or debris in the room. If you do not wish the filter sign to be displayed, select the setting value for "No indication".

(◆... Factory setting)

Setting description	Function number	Setting value
Standard	11	00
Long interval		01
Short interval		02
No indication		03

◆

The filter sign interval time is different according to Indoor unit type as follows.

Setting description	Floor
Standard	400 hours
Long interval	1000 hours
Short interval	200 hours

2) Embedding the indoor unit in a wall

When embedding the indoor unit in a wall, restrict the movement of the horizontal vane for the upper air outlet so that it only operates horizontally.

(◆... Factory setting)

	Setting description	Function number	Setting value
◆	Standard	23	00
	(Setting forbidden)		01
	In a wall		02

3) Cooler room temperature correction

Depending on the installed environment, the room temperature sensor may require a correction.

The settings may be selected as shown in the table below.

(◆... Factory setting)

	Setting description	Function number	Setting value
◆	Standard	30	00
	Slightly lower control		01
	Lower control		02
	Warmer control		03

4) Heater room temperature correction

Depending on the installed environment, the room temperature sensor may require a correction.

The settings may be changed as shown in the table below.

(◆... Factory setting)

	Setting description	Function number	Setting value
◆	Standard	31	00
	Lower control		01
	Slightly warmer control		02
	Warmer control		03

5) Auto restart

Enable or disable automatic system restart after a power outage.

(◆... Factory setting)

Setting description	Function number	Setting value
Yes	40	00
No		01

*Auto restart is an emergency function such as for power failure etc.
Do not start and stop the indoor unit by this function in normal operation.
Be sure to operate by the control unit, or external input device.

6) Indoor room temperature sensor switching function

(Only for Wired remote controller)

The following settings are needed when use the control by Wired remote controller temperature sensor.

(◆... Factory setting)

Setting description	Function number	Setting value
No	42	00
Yes		01

*If setting value is "00" :
Room temperature is controlled by the indoor unit temperature sensor.

*If setting value is "01" :
Room temperature is controlled by either indoor unit temperature sensor or remote controller unit sensor.

7) Remote controller signal code

Change the indoor unit Signal Code, depending on the remote controllers.

(◆... Factory setting)

Setting description	Function number	Setting value
A	44	00
B		01
C		02
D		03

8) External input control

"Operation/Stop" mode or "Forced stop" mode can be selected.

(◆... Factory setting)

Setting description	Function number	Setting value
Operation/Stop mode	46	00
(Setting forbidden)		01
Forced stop mode		02

■ REMOTE CONTROLLER SIGNAL CODE SETTING

Use the following steps to select the signal code of the remote controller.

(Note that the air conditioner cannot receive a signal code if the air conditioner has not been set for the signal code.)

1. Press the START/STOP button until only the clock is displayed on the remote controller display.
2. Press the MODE button for at least five seconds to display the current signal code (initially set to **A**).
3. Press the SET TEMP. (**▲**) (**▼**) button to change the signal code between **A** → **b** → **c** → **d**.
Match the code on the display to the air conditioner signal code.
4. Press the MODE button again to return to the clock display. The signal code will be changed.

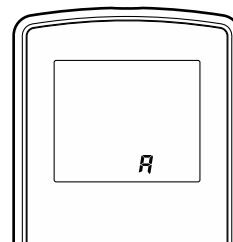





If no buttons are pressed within 30 seconds after the signal code is displayed, the system returns to the original clock display. In this case, start again from step 1.

The air conditioner signal code is set to A prior to shipment.
Contact your retailer to change the signal code.

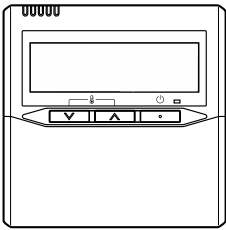
The remote controller resets to signal code A when the batteries in the remote controller are replaced. If you use a signal code other than signal code A, reset the signal code after replacing the batteries. If you do not know the air conditioner signal code setting, try each of the signal codes (**A** → **b** → **c** → **d**) until you find the code which operates the air conditioner.

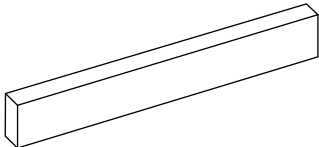
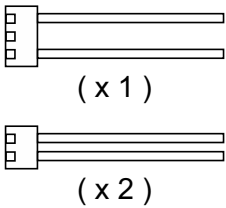
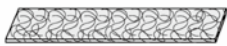
13. OPTIONAL PARTS

Exterior	Parts name	Model No.	Summary
	Wired remote controller	UTY-RNN*M	Unit control is performed by wired remote controller.
	Simple remote controller	UTY-RSN*M	Compact remote controller concentrates on the basic functions such as Start/Stop, Fan Control, Temperature Setting and Operation mode.
	Half concealed kit	UTR-STA	Using the Unit installing of half concealed.
 <p>(x 1)</p> <p>(x 2)</p>	External connect kit	UTY-XWZXZ5	Required when external device is connected.
	Apple-catechin filter	UTR-FC03-2	Fine dust, invisible mold spores, and harmful microorganisms are absorbed onto the filter by static electricity , and further growth is inhibited and deactivated by the polyphenol ingredient extracted from apples.
	Ion deodorization filter	UTR-FC03-3	The filter deodorizes by powerfully decomposing absorbed odors using the oxidizing and reducing effects of ions generated by the ultra fine-particle ceramic.

2. OUTDOOR UNIT

SINGLE TYPE :

AO*G09LVCN

AO*G12LVCN

AO*G14LVCN

CONTENTS

2. OUTDOOR UNIT

1. SPECIFICATIONS.....	02 - 01
2. DIMENSIONS	02 - 02
3. REFRIGERANT CIRCUIT	02 - 03
4. WIRING DIAGRAMS.....	02 - 05
5. CAPACITY COMPENSATION RATE FOR PIPE LENGTH AND HEIGHT DIFFERENCE	02 - 07
6. ADDITIONAL CHARGE CALCULATION.....	02 - 09
7. AIR FLOW	02 - 10
8. OPERATION NOISE.....	02 - 11
8-1. NOISE LEVEL CURVE	02 - 11
8-2. SOUND LEVEL CHECK POINT	02 - 13
9. ELECTRIC CHARACTERISTICS.....	02 - 14
10. SAFETY DEVICES	02 - 15

1. SPECIFICATIONS

Type			INVERTER HEAT PUMP		
Model name			AO*G09LVCN	AO*G12LVCN	AO*G14LVCN
Power source			230V ~ 50Hz		
Available voltage range			198-264V ~ 50Hz		
Starting current			A	3.9	5.6
Fan	Airflow rate	Cooling	m ³ /h	2,050	
		Heating		2,355	
	Type×Q'ty		2,000		
	Motor output		W	Propeller fan×1 115	
Sound pressure level	Cooling	dB(A)	47	48	52
	Heating		49	50	51
Heat exchanger type	Dimensions(H×W×D)		mm	588 x 881 x 36.4	
	Fin pitch			1.3	
	Rows×Stages			2 × 28	
	Pipe type			Copper	
	Fin Type			Aluminium	
Compressor	Type×Q'ty		Rotary × 1		
	Motor output		W	850	1,000
Refrigerant	Type		R410A		
	Charge	g	1,250	1,300	
Refrigerant oil	Type		POE(VG74)		
Enclosure	Material		Steel		
	Colour		Beige Approximate colour of MUNSELL 10YR7.5/1.0		
Dimensions (H×W×D)	Net		mm	620 × 790 × 290	
	Gross			713 × 945 × 395	
Weight	Net		kg	40	
	Gross			43	
Connenction pipe	Size	Liquid	mm	Ø6.35 (Ø1/4 in.)	
		Gas		Ø9.52 (Ø3/8 in.)	Ø12.70 (Ø1/2 in.)
	Method		Flare		
	Pre-charge length		m	15	
	Max. length			20	
	Max. height difference			15	
Operation range	Cooling	°C	10 to 43		
	Heating		-25 to 24		

Note :

Specifications are based on the following conditions.

Cooling : Indoor temperature of 27 °CDB / 19 °CWB.and outdoor temperature of 35 °CDB/24 °CWB.

Heating : Indoor temperature of 20 °CDB / 15 °CWB.and outdoor temperature of 7 °CDB/6 °CWB.

Pipe length : 5 m, Height difference : 0 m.(Outdoor unit - Indoor unit)

The maximum current is the maximum value when the operated within the operation range (temperature).

The protective function might work when using it outside the operation range.

2. DIMENSIONS

■ MODEL : AO*G09LV, AO*G12LV, AO*G14LV

(Unit : mm)

OUTDOOR UNIT
AO*G09-14LV

OUTDOOR UNIT
AO*G09-14LV

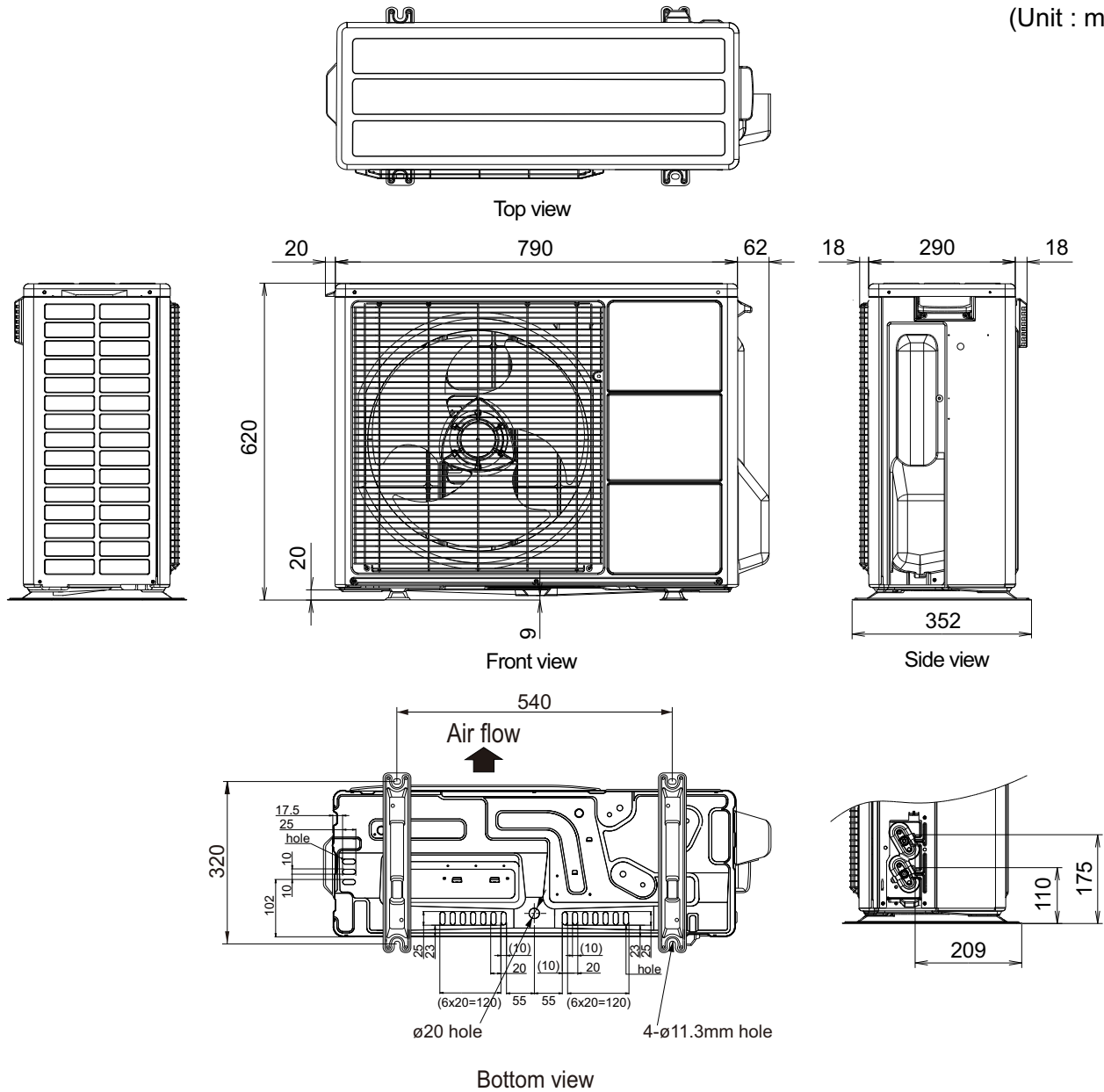

■ INSTALLATION PLACE

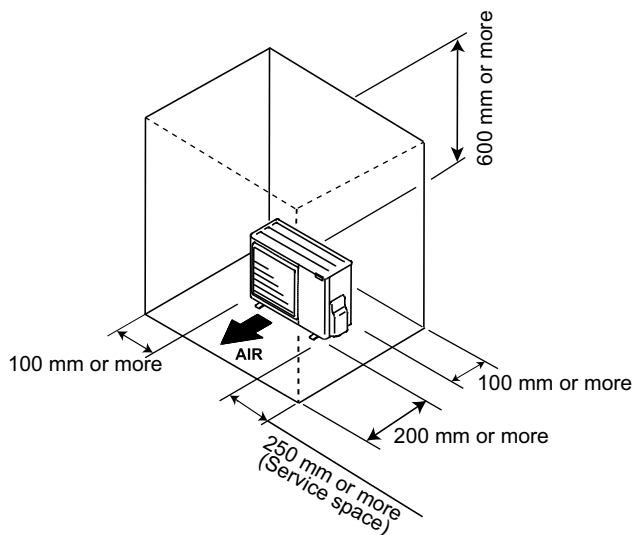

⚠ CAUTION

In the area with heavy snowfall, if the intake and outlet of outdoor unit is blocked with snow, it might become difficult to get warm and it is likely to cause of the breakdown. Construct a canopy or baffle board stand.

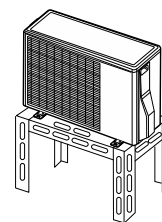

If the space is larger that is stated, the condition will be the same as that are no obstacles.

3. REFRIGERANT CIRCUIT

■ MODEL: AO*G09LV, AO*G12LV

OUTDOOR UNIT
AO*G09-14LV

OUTDOOR UNIT
AO*G09-14LV

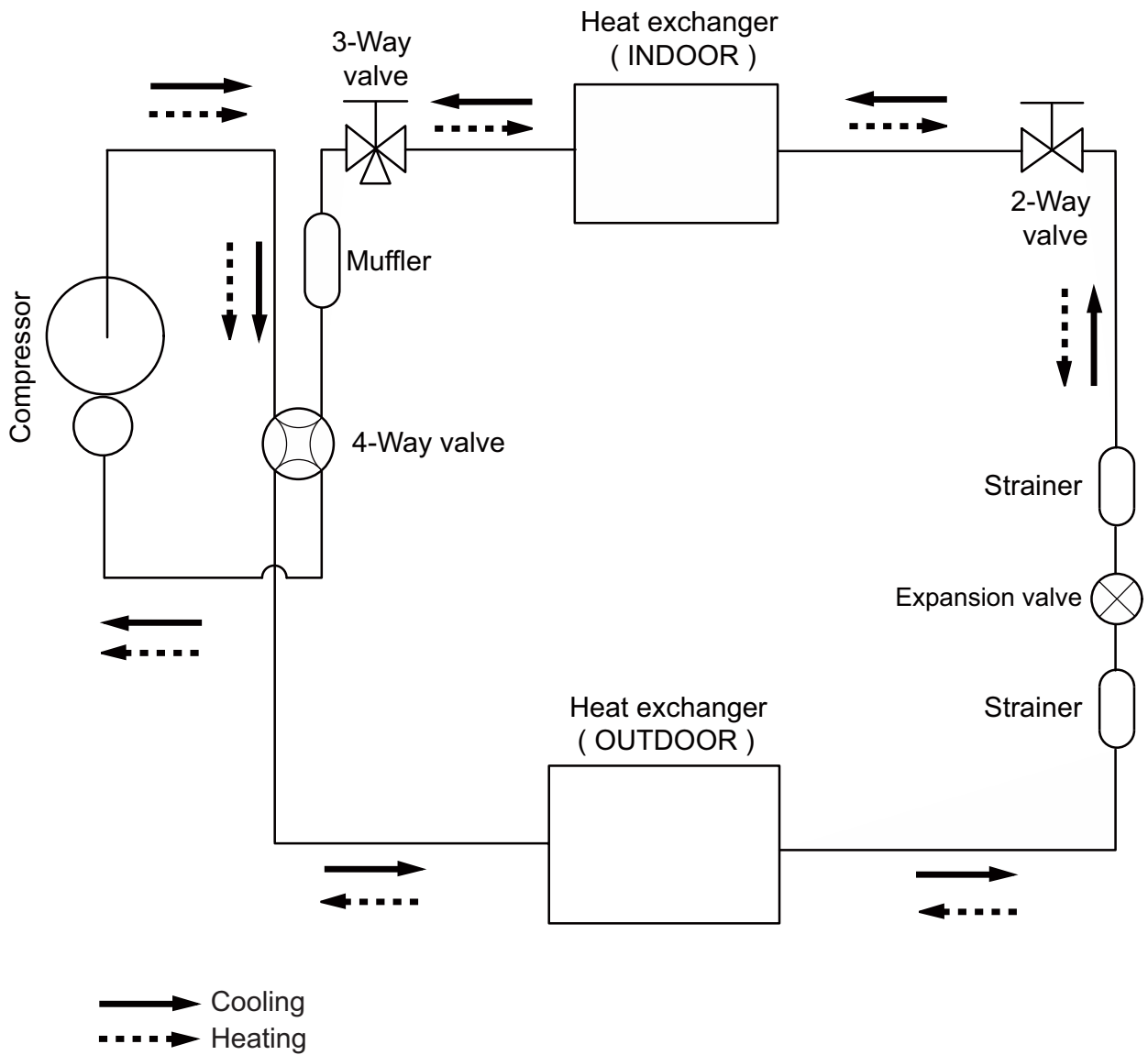



Refrigerant pipe diameter
Liquid : 1/4" (6.35 mm)
Gas : 3/8" (9.52 mm)

■ MODEL: AO*G14LV

OUTDOOR UNIT
AO*G09-14LV

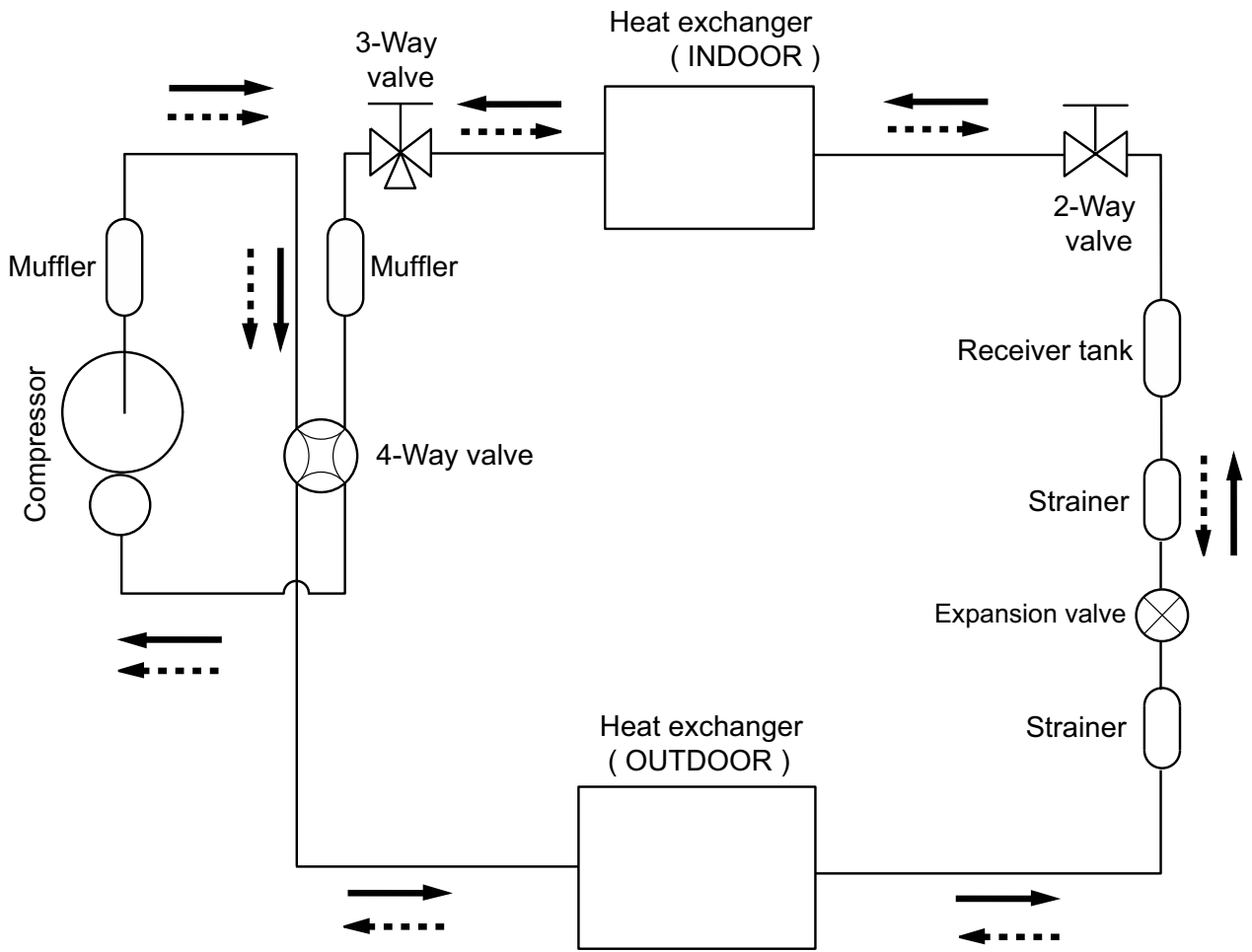
OUTDOOR UNIT
AO*G09-14LV



 Cooling
 Heating

Refrigerant pipe diameter
 Liquid : 1/4" (6.35 mm)
 Gas : 1/2" (12.70 mm)

4. WIRING DIAGRAMS

■ MODEL: AO*G09LV, AO*G12LV

OUTDOOR UNIT
AO*G09-14LV

OUTDOOR UNIT
AO*G09-14LV

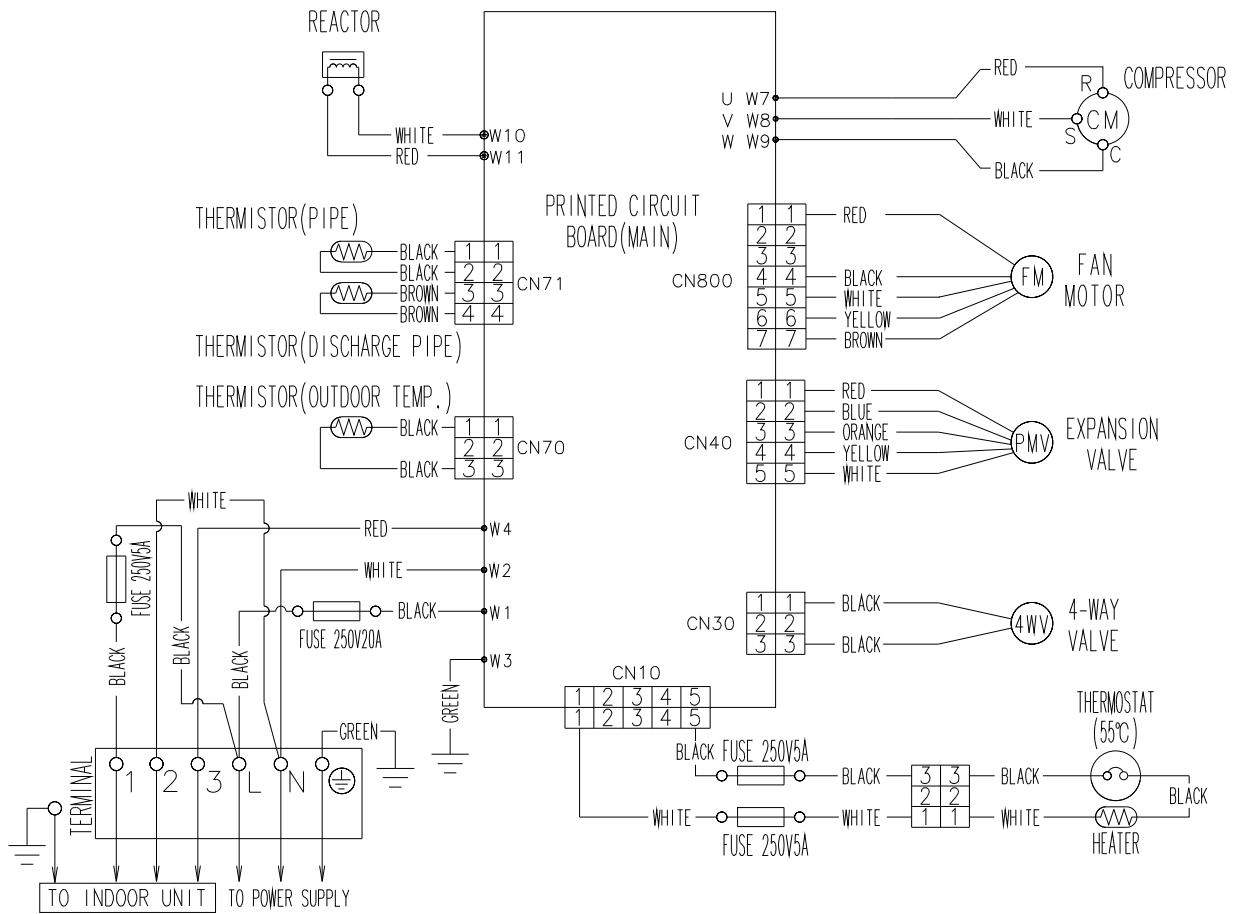

MODEL: AO*G14LV

OUTDOOR UNIT
AO*G09-14LV

OUTDOOR UNIT
AO*G09-14LV

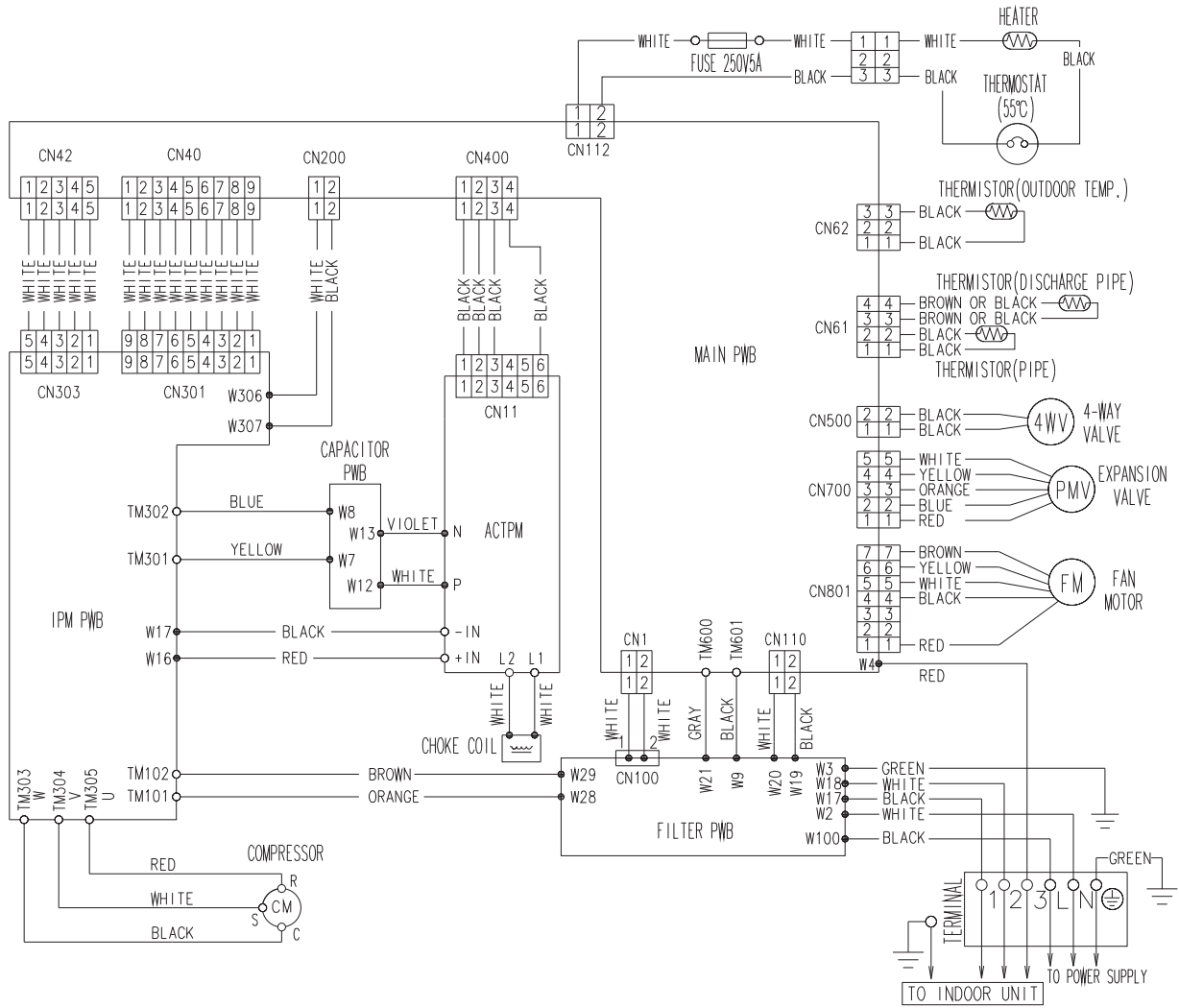

5. CAPACITY COMPENSATION RATE FOR PIPE LENGTH AND HEIGHT DIFFERENCE

MODEL: AO*G09LV, AO*G12LV

OUTDOOR UNIT
AO*G09-14LV

OUTDOOR UNIT
AO*G09-14LV

COOLING			Pipe length (m)				
			5	7.5	10	15	20
Height difference H (m)	*1 Indoor unit is upper than outdoor unit.	15	-	-	-	0.893	0.909
		10	-	-	0.955	0.908	0.924
		7.5	-	0.975	0.959	0.912	0.928
		5	0.992	0.979	0.963	0.916	0.931
	0		1.000	0.987	0.970	0.923	0.939
	*2 Indoor unit is under than outdoor unit	-5	1.000	0.987	0.970	0.923	0.939
		-7.5	-	0.987	0.970	0.923	0.939
		-10	-	-	0.970	0.923	0.939
		-15	-	-	-	0.923	0.939

HEATING			Pipe length (m)				
			5	7.5	10	15	20
Height difference H (m)	*1 Indoor unit is upper than outdoor unit.	15	-	-	-	0.956	0.938
		10	-	-	1.004	0.956	0.938
		7.5	-	1.013	1.004	0.956	0.938
		5	1.000	1.013	1.004	0.956	0.938
	0		1.000	1.013	1.004	0.956	0.938
	*2 Indoor unit is under than outdoor unit	-5	0.995	1.008	0.999	0.951	0.933
		-7.5	-	1.005	0.997	0.948	0.931
		-10	-	-	0.994	0.946	0.929
		-15	-	-	-	0.937	0.919

Height difference H

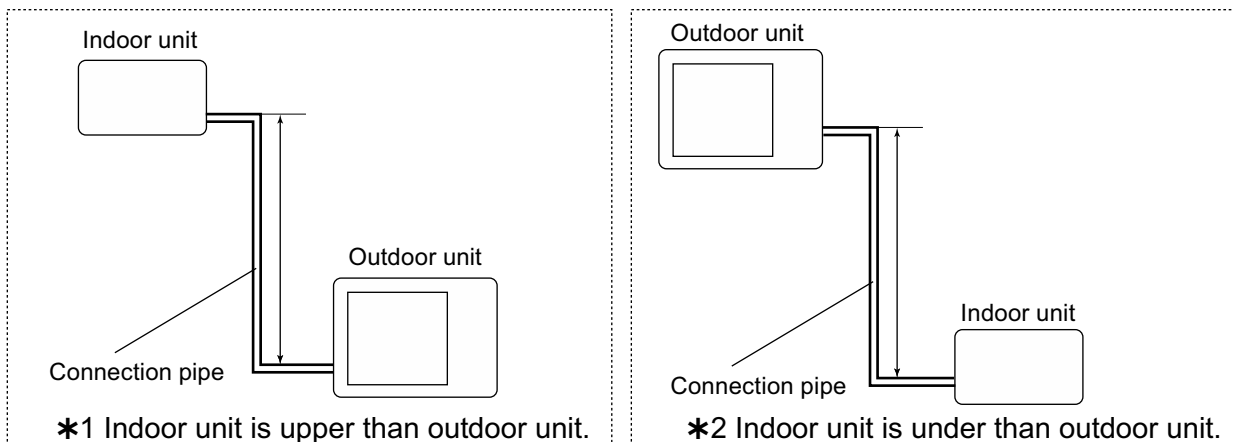

MODEL: AO*G14LV

OUTDOOR UNIT
AO*G09-14LV

OUTDOOR UNIT
AO*G09-14LV

COOLING			Pipe length (m)				
			5	7.5	10	15	20
Height difference H (m)	*1 Indoor unit is upper than outdoor unit.	15	-	-	-	0.951	0.950
		10	-	-	0.979	0.967	0.966
		7.5	-	0.988	0.983	0.971	0.970
		5	0.994	0.992	0.987	0.975	0.974
		0	1.002	1.000	0.995	0.983	0.982
	*2 Indoor unit is under than outdoor unit.	-5	1.002	1.000	0.995	0.983	0.982
		-7.5	-	1.000	0.995	0.983	0.982
		-10	-	-	0.995	0.983	0.982
		-15	-	-	-	0.983	0.982

HEATING			Pipe length (m)				
			5	7.5	10	15	20
Height difference H (m)	*1 Indoor unit is upper than outdoor unit.	15	-	-	-	0.994	0.979
		10	-	-	1.012	0.994	0.979
		7.5	-	1.000	1.012	0.994	0.979
		5	0.969	1.000	1.012	0.994	0.979
		0	0.969	1.000	1.012	0.994	0.979
	*2 Indoor unit is under than outdoor unit.	-5	0.964	0.995	1.007	0.989	0.974
		-7.5	-	0.993	1.004	0.986	0.972
		-10	-	-	1.002	0.984	0.969
		-15	-	-	-	0.974	0.959

Height difference H

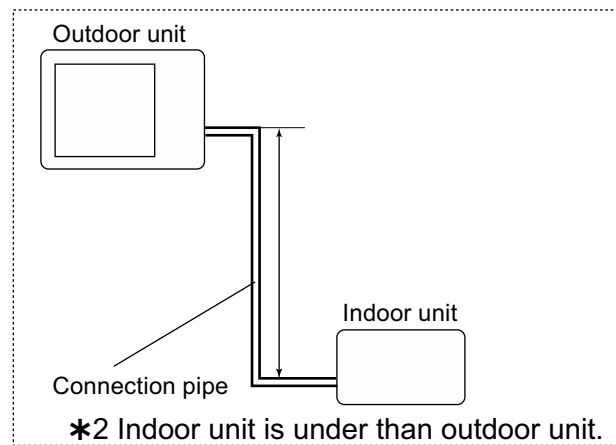
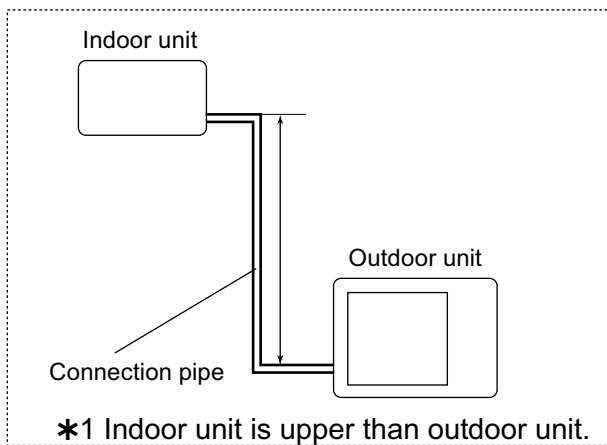

6. ADDITIONAL CHARGE CALCULATION

■ MODEL: AO*G09LV, AO*G12LV

Refrigerant type		R410A
Refrigerant amount	g	1250

● Refrigerant charge

Total pipe length	m	15 or less	20 (MAX)	20g/m
Additional charge	g	0	100	

■ MODEL: AO*G14LV

Refrigerant type		R410A
Refrigerant amount	g	1300

● Refrigerant charge

Total pipe length	m	15 or less	20 (MAX)	20g/m
Additional charge	g	0	100	

7. AIR FLOW

■ MODEL: AO*G09LV, AO*G12LV

● Cooling

Number of rotations (r.p.m.)	Air flow	
	870	2,050
569		l/s
1,206		CFM

● Heating

Number of rotations (r.p.m.)	Air flow	
	780	2,000
556		l/s
1,177		CFM

■ MODEL: AO*G14LV

● Cooling

Number of rotations (r.p.m.)	Air flow	
	1,000	2,355
654		l/s
1,386		CFM

● Heating

Number of rotations (r.p.m.)	Air flow	
	780	2,000
556		l/s
1,177		CFM

8. OPERATION NOISE

8-1. NOISE LEVEL CURVE

MODEL: AO*G09LV

● Cooling

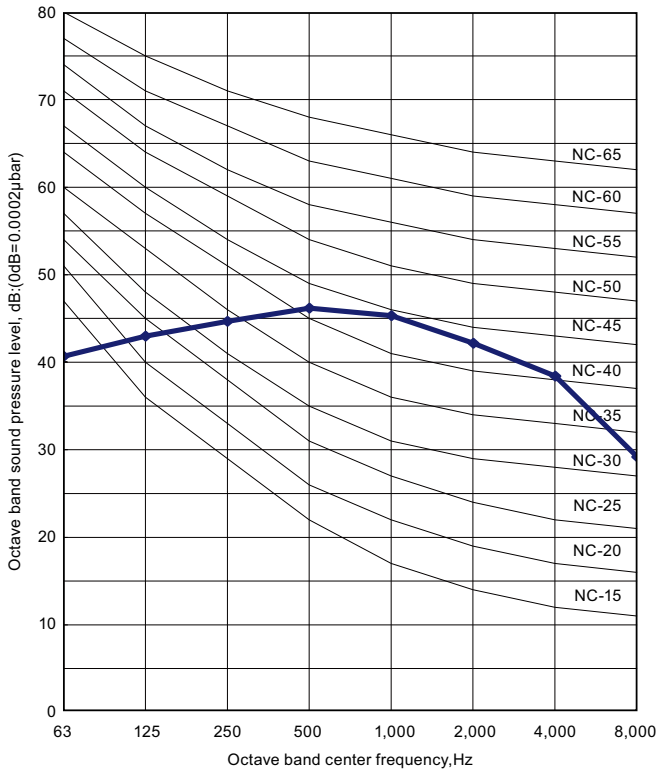

● Heating

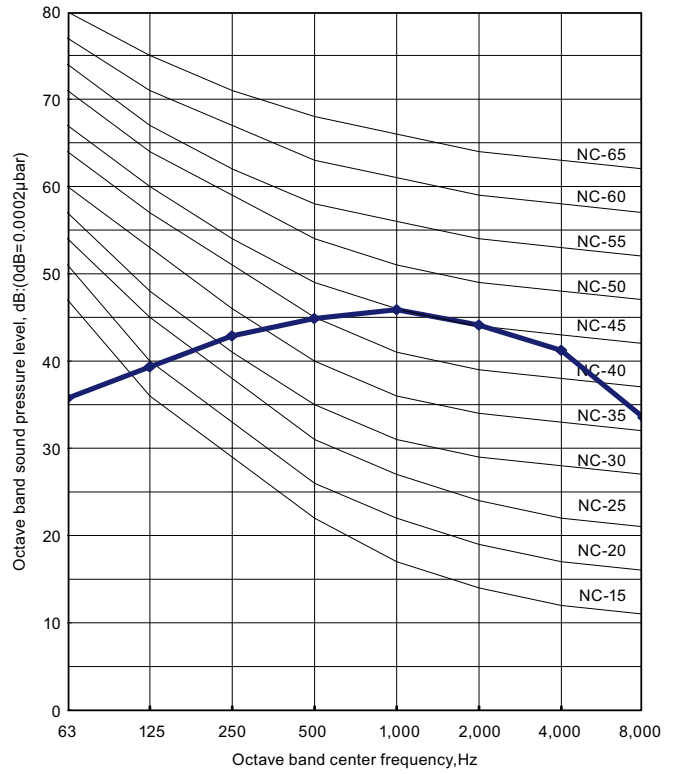

MODEL: AO*G12LV

● Cooling

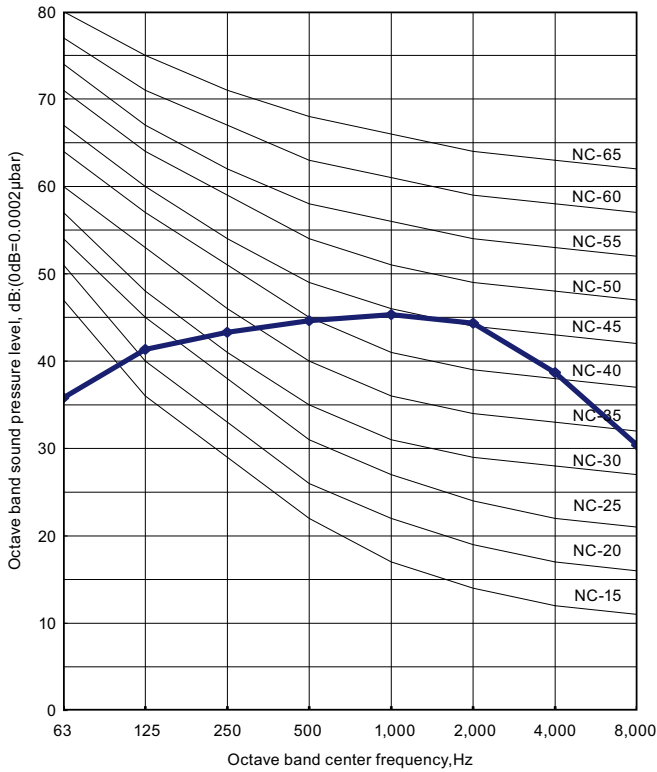

● Heating

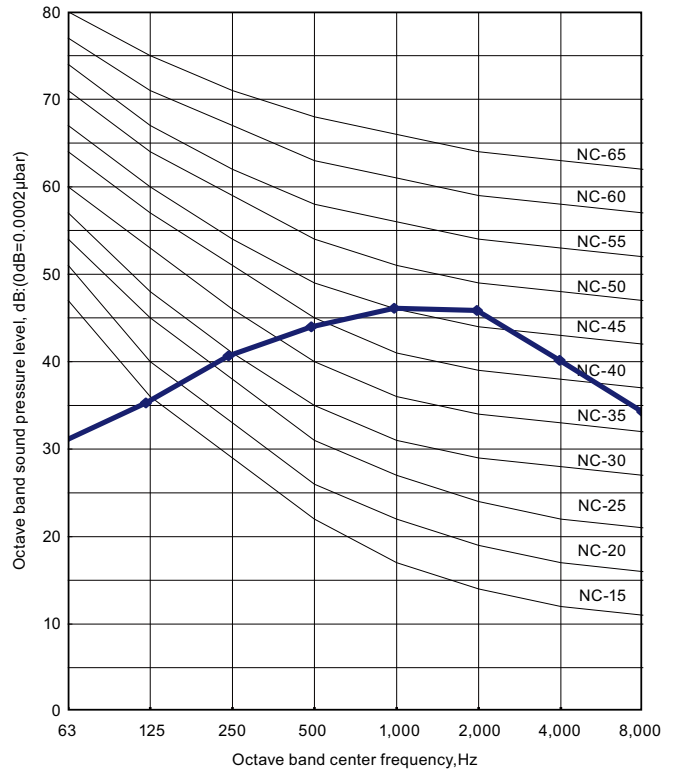

OUTDOOR UNIT
AO*G09-14LV

OUTDOOR UNIT
AO*G09-14LV

MODEL: AO*G14LV

● Cooling

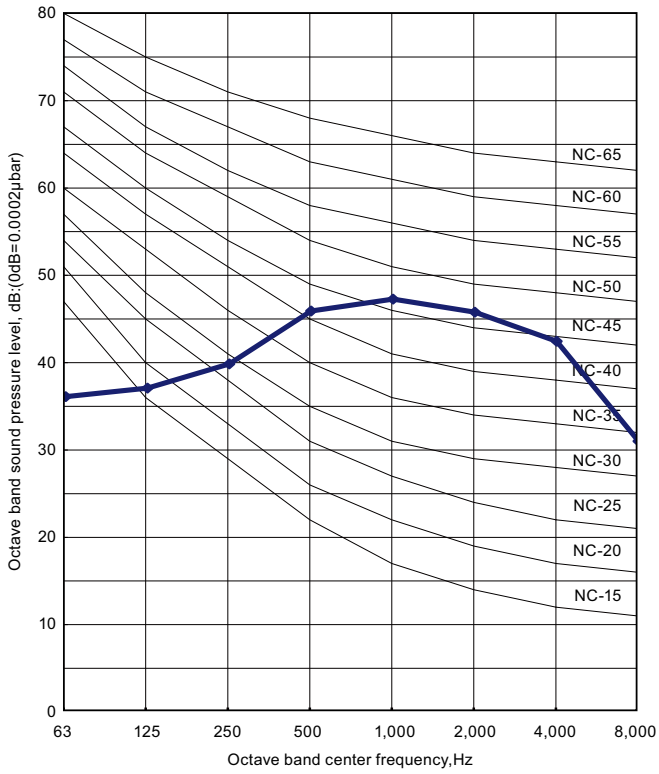

● Heating

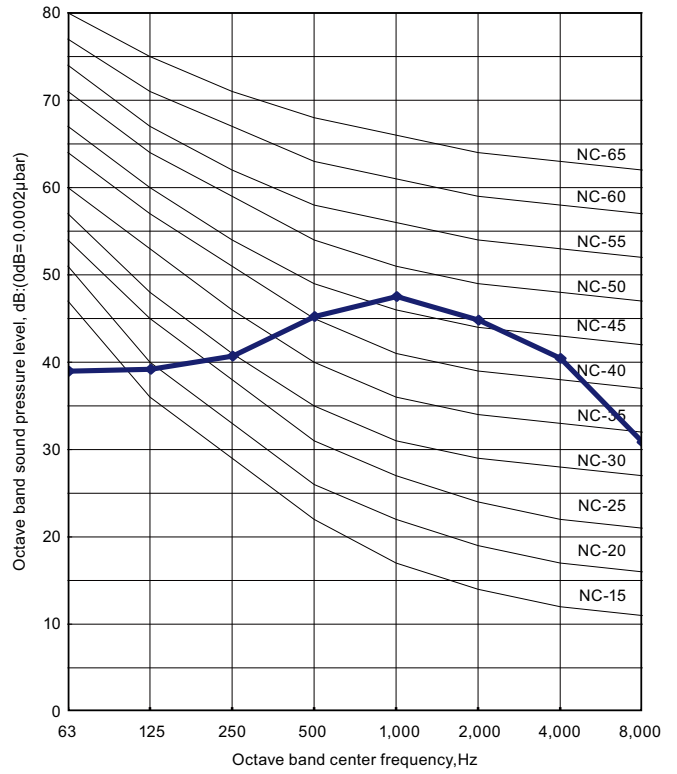

8-2. SOUND LEVEL CHECK POINT

OUTDOOR UNIT
AO*G09-14LV

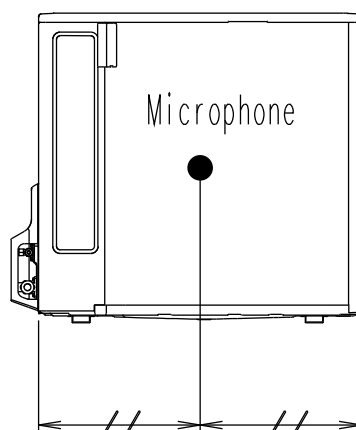
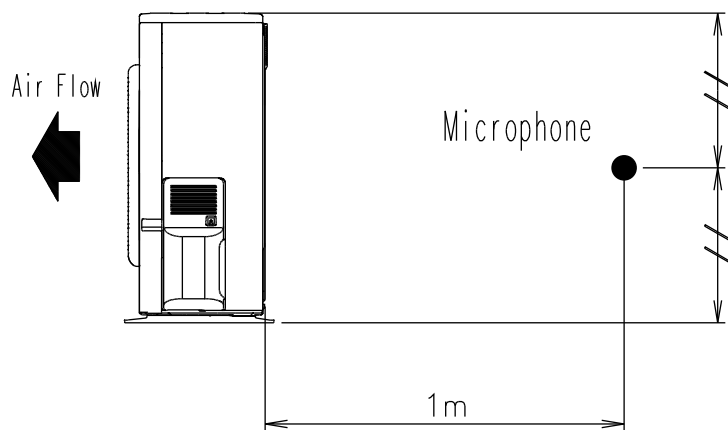

OUTDOOR UNIT
AO*G09-14LV

9. ELECTRIC CHARACTERISTICS

Model name			AO*G09LV	AO*G12LV	AO*G14LV
Power supply	Voltage	V	230 ~		
	Frequency	Hz	50		
*1) Max operating current		A	11.5		14.5
Starting Current		A	3.9	5.6	6.5
*2) Wiring Spec.:	Main Fuse (Circuit breaker) Current	A	15		20
	Power Cable	mm ²	1.5		3.5-4.0
	*3) Limited wiring length :	m	13		21

*1) The maximum current is the total current of indoor unit and outdoor unit.

*2) Wiring Spec.:

Selected Sample

(Selected based on Japan Electrotechnical Standard and Codes Committee E0005)

*3) Limited wiring length :

This is the wiring length in case voltage descent is less than 2%.

When the wiring length becomes long, please select the wiring of a more larger diameter.

10. SAFETY DEVICES

	Protection form	Model		
		AO*G09LV	AO*G12LV	AO*G14LV
Circuit protection	Current fuse (NEAR THE TERMINAL)	—		20A 250V
	Current fuse (MAIN PRINTED CIRCUIT BOARD)	20A 250V		10A 250V
		5A 250V		3.15A 250V
Fan motor protection	Thermal protection program	OFF : 100±10°C ON : 95±10°C		
Compressor protection	Thermal protection program (DISCHARGE TEMP.)	OFF : 110°C ON : After 7 minutes		

OUTDOOR UNIT
AO*G09-14LV

OUTDOOR UNIT
AO*G09-14LV